

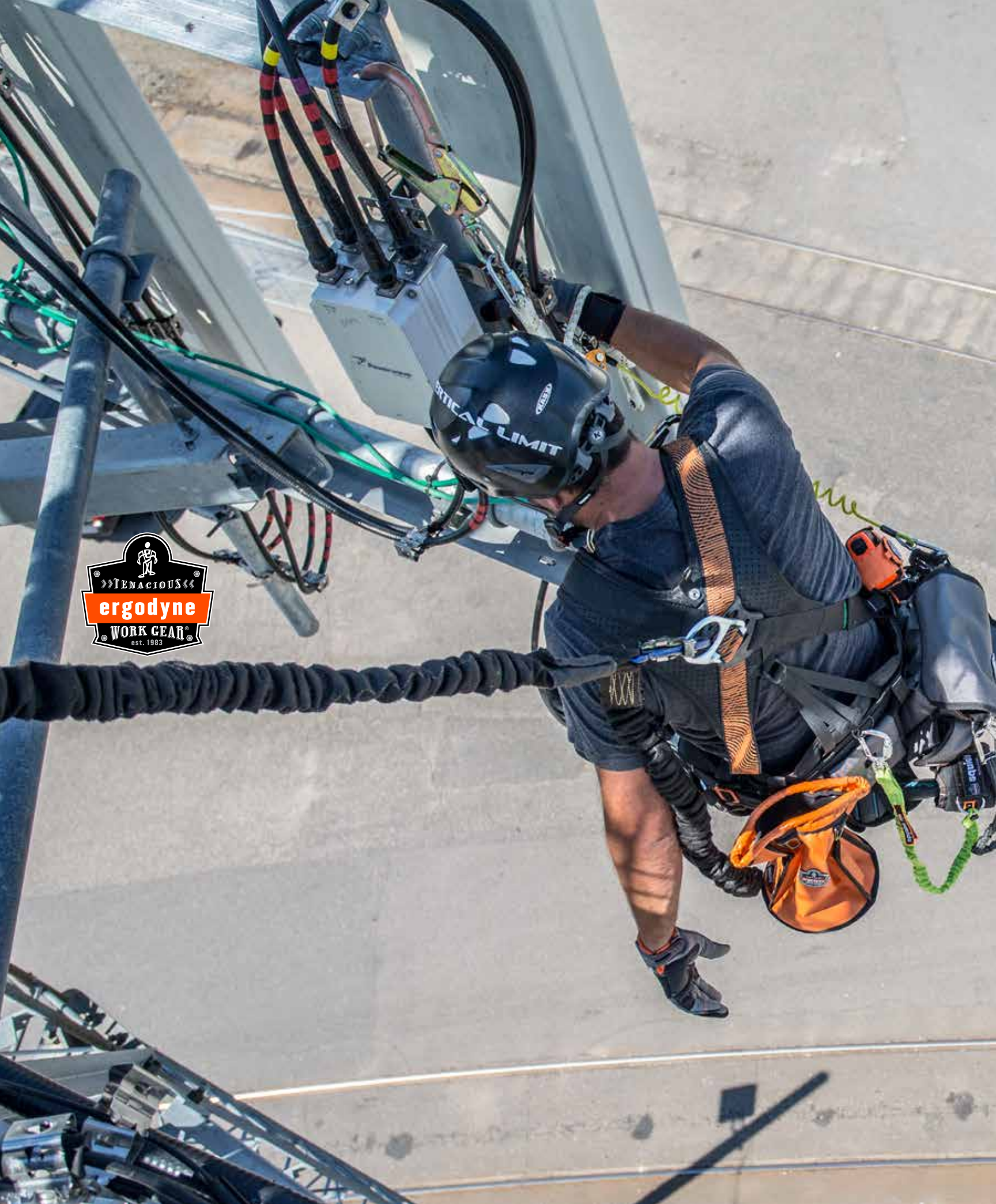

//BETENACIOUS//

2016 WORKBOOK: 33 YEARS OF TENACITY



VERTICAL LIMIT

ergodyne

WORK GEAR

est. 1983

EVOLUTION OF SAFETY.

Every so often there comes a tectonic shift that alters the current order of things: protoplasmic ooze becomes self-aware and eventually creates Hot Pockets. A meteor takes a left turn at Albuquerque and slams into the Yucatan giving the terrible lizards a permanent eviction notice. Al Gore invents the Internet. The list goes on. Well, we may not have instigated an Extinction Level Event (you're welcome, by the way) but we'd like to think that sometime around that 80's epoch of Madonna, The Noid, and Beverly Hills Cop, we caused something of a ripple. And that's all it takes, really. A ripple one year is a tidal wave the next. And before you know it, the world you knew is altered forever. Now, faithful workers and safety pros, you have access to a cornucopia of the finest safety solutions we have to offer. For years, we've strived to innovate and challenge the status quo. With a little help from our friends, natural selection, and a heapin' helpin' of tenacity, we've put together a war chest of safety implements to ensure you've got what you need to get the job done. Over the next couple hundred pages, you'll bear witness to a new era of Ergo Evolution.

PPE: PROTECTION. PRO

**THREE PRODUCT PILLARS, ONE PURPOSE.
MAKE THE WORKPLACE A BETTERPLACE.™**

Life is good when everything is humming together in concert. Three lines of a haiku: art. Three chords for Johnny Ramone: rebellion. Three flavors of Neapolitan ice cream: happiness. We understand that kind of synchronicity should be embraced and aspired to. And it's in that same spirit that we endeavor to provide you with a sweet song of PPE. Three pillars of safety upon which our Tenacious Work Gear® is built. We strive to provide Protection, increase your Productivity and help manage the Elements you face daily in the fields, mines, oceans, and deserts. We've put these interconnected safety pillars together to form a more perfect union and guarantee that you'll be covered from every angle no matter what your field excellence may be. You can trust that our years of expertise, drive, and innovation, combined with leading edge technology, will guide you to peak PPE performance. Let's Make the Workplace a Betterplace™.



DUCTIVITY. ELEMENTS.

{ PROVIDE }
PROTECTION

{ IMPROVE }
PRODUCTIVITY

{ MANAGE }
ELEMENTS

PROFLEX® GLOVES

Vibration-Reducing Series	Pgs. 20-21
Dorsal Impact-Reducing Series	Pgs. 22-23
Trades Series	Pgs. 24-27
Fire & Rescue Series	Pgs. 28-29
Thermal Series	Pgs. 30-31

PROFLEX® KNEE PADS

Gel Series	Pgs. 36-38
Standard Series	Pgs. 40-41
Kneeling Pad Series	Pgs. 42-43

PROFLEX® SUPPORTS

Back Support Series	Pgs. 48-49
Wrist Support Series	Pgs. 50-51
Wraps & Sleeves Series	Pgs. 52-53

GLOWEAR® HI-VIS APPAREL

Class 2 Vest Series	Pgs. 58-61
Class 3 & Class E Series	Pgs. 62-63
Non-Certified Series	Pg. 65
Shirt Series	Pgs. 66-68
Foul Weather Series	Pgs. 69-71
Headwear Series	Pgs. 72-73
Accessory Series	Pg. 73

SKULLERZ® EYE PROTECTION

Safety Glass Series	Pgs. 78-85
Accessory Series	Pgs. 86-87

SKULLERZ® HEAD PROTECTION

Bump Cap Series	Pgs. 90-91
-----------------	------------

SQUIDS® LANYARDS & WORKSITE ORGANIZERS

Connector Series	Pgs. 102-103
Tool Lanyard Series	Pgs. 104-106
Retractor Series	Pg. 107
Tool & Equipment Series	Pgs. 108-109
Grabber Series	Pgs. 110-111

ARSENAL® GEAR STORAGE

Packs & Duffel Series	Pgs. 116-117
PPE Storage Series	Pgs. 118-119
Public Safety Series	Pgs. 120-123
Hoist Bucket Series	Pgs. 124-127

ARSENAL® TOOL STORAGE

Belt & Accessory Series	Pgs. 132-135
Bag & Organizer Series	Pgs. 136-139

CHILL-ITS® COOLING PRODUCTS

Evaporative Series	Pgs. 148-155
Absorptive Series	Pgs. 156-157
Phase Change Series	Pgs. 158-159
Hydration Series	Pgs. 160-161

SHAX® PORTABLE WORK SHELTERS

Pop-Up Series	Pgs. 164-165
Umbrella Series	Pg. 165
Accessory Series	Pg. 165

N-FERNO® WARMING PRODUCTS

Heated Clothing & Acc. Series	Pgs. 170-171
Thermal Clothing Series	Pgs. 172-173
Thermal Liner Series	Pgs. 174-177
Thermal Balaclava Series	Pgs. 178-179
Thermal Hat & Cap Series	Pgs. 180-181
Thermal Accessory Series	Pgs. 182-183

TREX™ FOOTWEAR ACCESSORIES

Ice Traction Series	Pgs. 186-187
---------------------	--------------

CORE PERFORMANCE WORK WEAR®

FR Series	Pgs. 190-192
-----------	--------------

LEARN IT.

LIVE IT.

LOVE IT.

YOU AND THE ERGO WORKBOOK.
A LESSON IN USAGE.

Much like Halloween, the Super Bowl, and World Lizard Day, our workbook is an annual event. And this year we'd like you to meet the new boss. Not the same as the old boss. It's slick, sleek, and tricked out; we've improved upon a classic. Check out our condensed features and benefits on our product pages (just the facts, ma'am), as well as new indexes and tech tags to make cross referencing as easy as writing a new Fast and Furious movie. Dig in!

TECH TAGS

Sure, it looks cool. But what does it do? Use our handy tech tag icons and wonder no more.

PRODUCT NAME

What's in a name? How about trust, reliability, quality, integrity, accountability, notoriety, recognition? Must we go on?

STANDARDS CERTIFICATION

If a product complies with ANSI, ASTM — or graduated from any other school of hard knocks, you can bet we'll make a note of it.

PRODUCT PHOTO

Our gear is ready for its close-up, Mr. DeMille. And we've made sure to get its good side.

PATENT DESIGNATOR

Thomas Edison had 1,093 of these bad boys. We're hot on his trail.

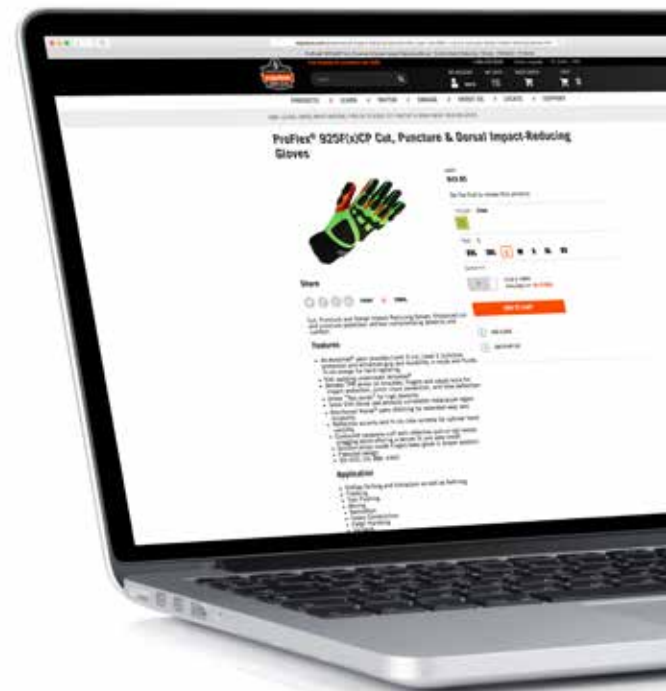

MODEL NUMBER

If we remember correctly it goes Kingdom, Phylum, Class, Family, Order, Genus, Model Number. Right?

ORDER MULTIPLE

You're ordering by the case, my friend. Check here for case quantities and minimum order requirements.

FEATURES & BENEFITS

If it can withstand the freeze, block out the sun, or lay golden eggs, we'll let you know about it.

ITEM NUMBERS

Item Numbers – the universal language. Use these to speak our native tongue and get exactly what you need.







925

F(x)

ORDER MULTIPLE
1

DORSAL IMPACT-REDUCING



4132
EN388



- Molded TPR armor for full dorsal impact protection
- Patented “flex zones” reduce hand fatigue
- 5mm EVA foam dorsal pad protects metacarpal bones
- Padded, reinforced palm with Armortex® zone
- Neoprene gauntlet cuff with reflective accents

ITEM #	SIZE	COLOR	ITEM #	SIZE	COLOR
16051	XS	HV Lime	16055	XL	HV Lime
16052	S	HV Lime	16056	2XL	HV Lime
16053	M	HV Lime	16057	3XL	HV Lime
16054	L	HV Lime			

// PATENTED

WWW.ERGODYNE.COM

Navigate through the series of tubes that is the Internet to find our humble web home. Find all you could ever want to know about our gear (and more!) – including things like videos, action photos, full list of features, benefits and resources (and more!) – and, of course, stay hip on all tenacious happenings. Move over, Huff Post, www.ergodyne.com is trending.

GET SOCIAL WITH US

Got Ergodyne FOMO? Follow us and cure what ails you. Don't know what FOMO is? Tweet us and we'll tell you.



TECH TAGS AND YOU. ICONS.

QUICKLY IDENTIFY THE ATTRIBUTES
THAT MATTER TO A PRODUCT OR RISK.



TECH TAGS

PERFORMANCE AND REGULATORY TAGS

We read somewhere that a symbol is an “object that condenses maximum resonance into minimum space.” Okay, we’re going with that. Look for these symbols to make some sense of the performance and regulatory characteristics that make our Tenacious Work Gear® drop kick the competition through the goal posts of life.



Abrasion Resistant



Acrylic Polymer Crystals



ANSI Compliant



Anti-Stink



Ballistic Material



Break-away Design



Captive Eye



Chemical Free



Computer Storage



CSA Compliant



Cut Resistant



Dorsal Protection



Dry Surface Grip Technology



EN Compliant



ESD / Non-Static



Flame Resistant



Foreign Materials Management



Hand Washable



Gel Polymer



Genuine Leather Construction



High Visibility



High Dexterity



Impact



Waterproof Membrane



LEDs



Machine Washable



Magnetic



Built with 3M Materials



Micro-Fiber



Modular Design



Moisture Management



Non-Conductive or ESD



OutDry® Waterproof Membrane



Patented Nu*O₂ Polymer



Patented Open-Center Stay™



P.A.L.S. Design



PVA Cooling Material



Patented Sticky Fingers® Stay



Puncture Resistant



1-Hand Operation



Reflective Accents



Rubber Base



Soil Release



Stainless Steel



Storm Drains



Swiveling Design



Touch Screen Compatible



Thermal



UV Protection



Water Repellent



Weight Rated



Wet Surface Grip Technology



Wheeled Design

NOW THE CLASSROOM COMES TO YOU.

ALL THIS KNOWLEDGE CAN'T BE CONTAINED IN FOUR WALLS.
WE'RE HITTING THE ROAD WITH OUR TAILGATE TALKS™.



Remember when the bookmobile used to roll into your local library and pass out tales of Goldilocks and Rip Van Winkle? Yawn. We feel your pain. Thus we humbly (not) present the Tenacious Assault Vehicle. Ready to thunder into town and give you the lowdown on the hazards and risks you encounter every day on the job. The TAV is a fully-loaded, fully-functional safety demo on wheels. With our top flight Tenacious Work Gear® on board and more know-how and training than you can shake a dipstick at. Get ready, we're rumbling to your town soon and you don't want to miss these Tailgate Talks™.



TAILGATE TALKS™

Want one on your jobsite? Email us at tenaciousnation@ergodyne.com

PAIN'T THE WORLD... ORANGE.

ON THE SALES FLOOR, CLAIM THE
SPACE, CONQUER THE BATTLEFIELD!



99705

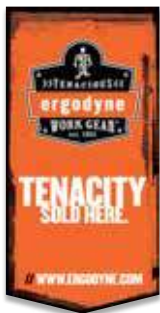

99715



99710

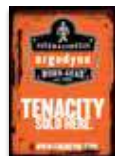

99720

MERCHANDISING BANNERS

“TENACITY SOLD HERE”

Horizontal Banner

- 96” x 36” (244 cm x 92 cm)

ITEM #99705

“TENACITY SOLD HERE”

Horizontal Banner

- 48” x 24” (122 cm x 61 cm)

ITEM #99710

“TENACITY SOLD HERE”

Vertical Banner

- 24” x 48” (61 cm x 122 cm)

ITEM #99715

“TENACITY SOLD HERE”

Authorized Dealer Door Clings

- 5” X 7” (13 cm x 18 cm)

ITEM #99720 (Packed in Sets of 10)

GLOVE LOVE ONE-PANEL DISPLAY KIT

DISPLAYS APPROXIMATELY
120 PAIR OF PROFLEX® GLOVES

- 24” x 72” (61 cm x 183 cm)

ITEM #99815



99815

The Glengarry leads? Sorry, we can't help you there. But we can provide you with an array of merchandisers that are strong enough for your sales floor and pH balanced for our gear. They're designed to show off the goods and move units. We've got fixtures, displays, cases, and signage to highlight the finer points of all of our Tenacious Work Gear® and have it flying off your shelves and into the loving arms (heads, legs, etc.) of our favorite workers. Contact our crackerjack staff to get the lowdown and get outfitted with the latest and greatest we have to offer. Sound good? Just one more thing: PUT. THAT. COFFEE. DOWN. Just kidding, you earned it.



99814

TENACIOUS WORK GEAR® ONE-PANEL GRID DISPLAY KIT

TWO-SIDED DISPLAY WITH 32 HOOKS AND TENACIOUS WORK GEAR® HEADER

- 24" x 72" (61 cm x 183 cm)
ITEM #99814



99846
*Require Slat Wall

CORE FR™ WATERFALL DISPLAY AND HANGER KIT

ONE (1) WATERFALL AND TEN (10) HANGERS - KIT
ITEM #99823

- HANGERS ONLY (10)
ITEM #99821

WATERFALL DISPLAY ONLY (1)
• 10" x 17" (25 cm x 43 cm)
ITEM #99846



99848



99847

EYEWEAR DISPLAYS

12 PAIR LOCKING DISPLAY

- 15" w x 27" h x 12" d
(38 cm x 69 cm x 30 cm)
ITEM #99848

7 PAIR NON-LOCKING DISPLAY

- 10" w x 27" h x 14" d
(25 cm x 69 cm x 35 cm)
ITEM #99847



PROTECTOR



TECTION



PROFLEX®

- » GLOVES
- » KNEE PADS // KNEELING PADS
- » BACK SUPPORTS
- » SUPPORTS // WRAPS // SLEEVES

GLÖWEAR®

- » VESTS // SHIRTS
- » FOUL WEATHER GEAR
- » HEADWEAR
- » ACCESSORIES

SKULLERZ®

- » EYE PROTECTION
- » HEAD PROTECTION





GLOVE TO GLOVE Y

PROFLEX[®]
GLOVES

YOU, BABY.



PROFLEX® GLOVES

Without opposable thumbs you know what we'd be? Spider Monkeys. How does that sound? Not so good. So take care of the digits that dote on you. With ProFlex® Gloves' combination of durability and world class technological advancements from high-tech stuff like Armortex®, AX Suede™, OutDry®, and Thinsulate™, we've got a phalanx of protection for your phalanges. We'd say that deserves a hand, don't you think?

GLOVES // VIBRATION-REDUCING SERIES



9015 F(x) Certified Dorsal



9002 Certified



9012 Certified w/ Wrist Support



9000 Lightweight Certified

GLOVES // DORSAL IMPACT-REDUCING SERIES



920 Nitrile-Dipped



921 Rubber-Dipped Thermal



922CR Level 5 Cut Resistant



924LD Light Duty

GLOVES // TRADES SERIES



811 Hi-Dexterity Utility



812CL5 Utility + Cut 5



812TX Utility + Touch



815 QuickCuff™ Utility



GLOVES // TRADES SERIES



710 Heavy Duty Utility



710CL5 Heavy Duty + Cut 5



710TX Heavy Duty + Touch



710LTR HD Leather Reinforced



GLOVES // THERMAL SERIES



819WP/OD Waterproof Gauntlet



818WP/OD Waterproof Utility



876WP Waterproof Hi-Vis



817/WP Waterproof



900 Impact



910 Impact w/ Wrist Support



901 Economy Impact



800 Liner



925F(x) Original



925F(x)CP Cut & Puncture Resistant



925F(x)WP Thermal Waterproof



925CPWP Thermal Waterproof CP



812 Utility



810 Reinforced Utility



821 Smooth Surface Handling



860 Lifting Handler



720 Heavy Duty Framing



720LTR HD Leather Framing



820 High Abrasion Handling



840 Leather Trades



816 Flip-Top Mitten

GLOVES
// FIRE & RESCUE
SERIES



730 Performance



7300D Performance OutDry®



740 Rope

PROFLEX® GLOVES:

VIBRATION-REDUCING SERIES

DIFFERENTIATED BY DESIGN:

CERTIFIED PROTECTION

Choose from four ANSI/ISO-certified gloves for maximum protection from harmful vibration and impact.

PIGSKIN LEATHER CONSTRUCTION

Durable pigskin leather palm construction built to stand up to the toughest applications.

GEL PALM

Patented 3-layer Nu²O₂ gel or visco-elastic gel polymer palm reduces vibration and dampens shock and impact.

NEOPRENE KNUCKLE PAD

Padded neoprene knuckle area protects while providing maximum comfort.

OPEN-CENTER STAY™

Built-in patented Open-Center Stay™ options provide additional support and relief from repetitive motion discomfort.



9012



FIND OUT MORE ABOUT THE TECHNOLOGY THAT GOES INTO THE FULL LINE OF ERGODYNE GLOVES AT: WWW.ERGODYNE.COM

			9015 _{F(x)}			ORDER MULTIPLE 1
CERTIFIED AV W/ DORSAL PROTECTION						
<p>3122 EN388</p>						
<ul style="list-style-type: none"> • ANSI S2.73/ISO 10819-certified AV protection • Patented Nu²O₂® gel polymer palm pad • Abrasion resistant pigskin leather palm • Molded TPR armor provides dorsal protection • Low-profile hook and loop closure with pull-on tab 						
ITEM #	SIZE	COLOR	ITEM #	SIZE	COLOR	
16232	S	Black	16235	XL	Black	
16233	M	Black	16236	2XL	Black	
16234	L	Black				
// PATENTED						

			900			ORDER MULTIPLE 1
IMPACT GLOVES						
<p>4143 EN388</p>						
<ul style="list-style-type: none"> • Gel polymer palm pads dampen shock and impact • Abrasion-resistant pigskin leather palm • Half-finger design for optimal dexterity • Neoprene knuckle pad • Low-profile hook and loop closure with pull-on tab 						
ITEM #	SIZE	COLOR	ITEM #	SIZE	COLOR	
17022	S	Black	17025	XL	Black	
17023	M	Black	17026	2XL	Black	
17024	L	Black				

9002

ORDER
MULTIPLE
1

CERTIFIED ANTI-VIBRATION GLOVES

3122
EN388

- ANSI S2.73/ISO 10819-certified AV protection
- Patented Nu²O₂® gel polymer palm pad
- Abrasion resistant pigskin leather palm
- Neoprene knuckle pad
- Low-profile hook and loop closure with pull-on tab

ITEM #	SIZE	COLOR	ITEM #	SIZE	COLOR
17322	S	Black	17325	XL	Black
17323	M	Black	17326	2XL	Black
17324	L	Black			

// PATENTED

9012

ORDER
MULTIPLE
1

CERTIFIED ANTI-VIBRATION GLOVES/ WRIST

3122
EN388

- ANSI S2.73/ISO 10819-certified AV protection
- Patented Nu²O₂® gel polymer palm pad
- Abrasion resistant pigskin leather palm
- Built-in wrist support with Open-Center Stay™
- Neoprene knuckle pad

ITEM #	SIZE	COLOR	ITEM #	SIZE	COLOR
17722	S	Black	17725	XL	Black
17723	M	Black	17726	2XL	Black
17724	L	Black			

// PATENTED

9000

ORDER
MULTIPLE
1

CERTIFIED LIGHTWEIGHT ANTI-VIBRATION

X243
EN388

- ANSI S2.73/ISO 10819-certified AV protection
- Unique chloroprene rubber palm pad
- Breathable 7-gauge cotton/nylon seamless knit
- Comfortable, flexible pre-curved design
- Elastic cuff for secure fit

ITEM #	SIZE	COLOR
16453	M	Black
16454	L	Black
16455	XL	Black

910

ORDER
MULTIPLE
1

IMPACT GLOVES W/ WRIST SUPPORT

4143
EN388

- Gel polymer palm pads dampen shock and impact
- Abrasion-resistant pigskin leather palm
- Half-finger design for optimal dexterity
- Built-in wrist support with Open-Center Stay™
- Neoprene knuckle pad

ITEM #	SIZE	COLOR	ITEM #	SIZE	COLOR
17422	S	Black	17425	XL	Black
17423	M	Black	17426	2XL	Black
17424	L	Black			

// PATENTED

901

ORDER
MULTIPLE
1

ECONOMY IMPACT

- EVA foam pads dampen shock and impact
- Split leather palm
- Half-finger design for optimal dexterity
- Hook and loop closure

ITEM #	SIZE	COLOR	ITEM #	SIZE	COLOR
17032	S	Black	17035	XL	Black
17033	M	Black	17036	2XL	Black
17034	L	Black			

800

ORDER
MULTIPLE
1

GLOVE LINER

- Gel polymer palm pads dampen shock and impact
- Breathable cotton/spandex body
- Half-finger design for optimal dexterity
- Can be worn alone or underneath separate gloves

ITEM #	SIZE	COLOR
16104	S/M	Black
16106	L	Black

PROFLEX® GLOVES:

DORSAL IMPACT-REDUCING SERIES

DIFFERENTIATED BY DESIGN:

FULL DORSAL PROTECTION

Molded rubber (TPR) armor and segmented foam protect the entire back of hand from pinches, crushes, and bruising blows.

MAXIMUM DEXTERITY

Patented finger protection is designed to flex vertically, working with the natural motion of the hand to reduce fatigue.



GRIPPING PALMS

Choose abrasion-resistant reinforcements, rugged Armortex®, or foam-dipped options for maximum grip and durability.

HIGH VISIBILITY

Hi-vis materials on both dorsal and palm sides combine with reflective accents to keep hands visible and allow for clear signaling.

CUT PROTECTION

Choose from Level 1, Level 3, or Level 5 cut-resistant options for protection in a variety of applications.

925F(x)



FIND OUT MORE ABOUT THE TECHNOLOGY THAT GOES INTO THE FULL LINE OF ERGODYNE GLOVES AT: WWW.ERGODYNE.COM

				920	ORDER MULTIPLE 12
NITRILE DIPPED DORSAL IMPACT-REDUCING					
<p>4121 EN388</p>					
<ul style="list-style-type: none"> • Molded TPR armor for full dorsal impact protection • Patented “flex zones” reduce hand fatigue • Abrasion-resistant foam nitrile gripping palm • Breathable 10-gauge poly/cotton seamless knit • Hi-vis for hand safety awareness and signaling 					
ITEM #	SIZE	COLOR	ITEM #	SIZE	COLOR
17002	S	HV Lime	17005	XL	HV Lime
17003	M	HV Lime	17006	2XL	HV Lime
17004	L	HV Lime			
// PATENTED					

				925	ORDER MULTIPLE 1
DORSAL IMPACT-REDUCING					
<p>4132 EN388</p>					
<ul style="list-style-type: none"> • Molded TPR armor for full dorsal impact protection • Patented “flex zones” reduce hand fatigue • 5mm EVA foam dorsal pad protects metacarpal bones • Padded, reinforced palm with Armortex® zone • Neoprene gauntlet cuff with reflective accents 					
ITEM #	SIZE	COLOR	ITEM #	SIZE	COLOR
16051	XS	HV Lime	16055	XL	HV Lime
16052	S	HV Lime	16056	2XL	HV Lime
16053	M	HV Lime	16057	3XL	HV Lime
16054	L	HV Lime			
// PATENTED					

921

ORDER MULTIPLE
12

THERMAL RUBBER-DIPPED DIR

2242
EN388

- Molded TPR armor for full dorsal impact protection
- Patented “flex zones” reduce hand fatigue
- Foam rubber gripping palm stays flexible in cold
- Thermal acrylic fleece seamless knit
- Hi-vis for hand safety awareness and signaling

ITEM #	SIZE	COLOR	ITEM #	SIZE	COLOR
17012	S	HV Lime	17015	XL	HV Lime
17013	M	HV Lime	17016	2XL	HV Lime
17014	L	HV Lime			

// PATENTED

922^{CR}

ORDER MULTIPLE
12

LEVEL 5 CUT RESISTANT NITRILE-DIPPED DIR

4543
EN388

- Molded TPR armor for full dorsal impact protection
- Patented “flex zones” reduce hand fatigue
- Reinforced sandy foam nitrile gripping palm
- 13-gauge HPPE seamless knit for Cut 5 protection
- Hi-vis for hand safety awareness and signaling

ITEM #	SIZE	COLOR	ITEM #	SIZE	COLOR
17092	S	Gray	17095	XL	Gray
17093	M	Gray	17096	2XL	Gray
17094	L	Gray			

// PATENTED

924^{LD}

ORDER MULTIPLE
1

LIGHT DORSAL IMPACT-REDUCING

4121
EN388

- Slim molded TPR armor provides impact protection
- Patented “flex zones” reduce hand fatigue
- 3mm EVA foam dorsal pad protects metacarpal bones
- Breathable air-mesh back; reinforced palm
- Neoprene cuff with hook and loop closure

ITEM #	SIZE	COLOR	ITEM #	SIZE	COLOR
17051	XS	HV Lime	17055	XL	HV Lime
17052	S	HV Lime	17056	2XL	HV Lime
17053	M	HV Lime	17057	3XL	HV Lime
17054	L	HV Lime			

// PATENTED

925^{F(x)CP}

ORDER MULTIPLE
1

CUT, PUNCTURE AND DORSAL IMPACT-REDUCING

4342
EN388

- Molded TPR armor for full dorsal impact protection
- Patented “flex zones” reduce hand fatigue
- 5mm EVA foam dorsal pad protects metacarpal bones
- Slip-resistant Armortex® palm for Cut 3 protection
- Neoprene gauntlet cuff with reflective accents

ITEM #	SIZE	COLOR	ITEM #	SIZE	COLOR
17071	XS	HV Lime	17075	XL	HV Lime
17072	S	HV Lime	17076	2XL	HV Lime
17073	M	HV Lime	17077	3XL	HV Lime
17074	L	HV Lime			

// PATENTED

925^{F(x)WP}

ORDER MULTIPLE
1

THERMAL WATERPROOF DIR

4132
EN388

- Molded TPR armor for full dorsal impact protection
- Patented “flex zones” reduce hand fatigue
- 40g 3M™ Thinsulate™ insulation; waterproof liner
- Padded, reinforced palm with Armortex® zone
- Neoprene gauntlet cuff with reflective accents

ITEM #	SIZE	COLOR	ITEM #	SIZE	COLOR
16191	XS	HV Lime	16195	XL	HV Lime
16192	S	HV Lime	16196	2XL	HV Lime
16193	M	HV Lime	16197	3XL	HV Lime
16194	L	HV Lime			

// PATENTED

925^{CPWP}

ORDER MULTIPLE
1

THERMAL WATERPROOF CUT, PUNCTURE & DIR

4342
EN388

- Molded TPR armor for full dorsal impact protection
- Patented “flex zones” reduce hand fatigue
- 40g 3M™ Thinsulate™ insulation; waterproof liner
- Slip-resistant Armortex® palm for Cut 3 protection
- Neoprene gauntlet cuff with reflective accents

ITEM #	SIZE	COLOR	ITEM #	SIZE	COLOR
17081	XS	HV Lime	17085	XL	HV Lime
17082	S	HV Lime	17086	2XL	HV Lime
17083	M	HV Lime	17087	3XL	HV Lime
17084	L	HV Lime			

// PATENTED

PROFLEX® GLOVES:

TRADES SERIES

DIFFERENTIATED BY DESIGN:

MAXIMUM DEXTERITY

Designed for flex and feel, high dexterity comes standard or choose the super Hi-Dex for maximum tactility.



BREATHABLE MESH

Comfortable, breathable mesh construction provides excellent dexterity and flexibility.

TECHNICAL OPTIONS

Choose TX touch screen capability, Cut Level 5 protection, or an out-of-this-world smooth surface gripping option.

812

SECURE FIT

Low-profile molded closure keeps gloves secure; QuickCuff™ option provides easy on/off.



FIND OUT MORE ABOUT THE TECHNOLOGY THAT GOES INTO THE FULL LINE OF ERGODYNE GLOVES AT: WWW.ERGODYNE.COM



811

ORDER MULTIPLE 1

HI-DEXTERITY UTILITY



- Super-thin 0.5mm high dexterity gripping palm
- Wrapped index finger for maximum feel
- Breathable poly mesh construction
- Low-profile molded hook and loop closure with ID
- Pull-on tab for easy on/off

ITEM #	SIZE	COLOR	ITEM #	SIZE	COLOR
17162	S	Black	17165	XL	Black
17163	M	Black	17166	2XL	Black
17164	L	Black			

// PATENT PENDING



812

ORDER MULTIPLE 1

UTILITY



- Durable synthetic leather palm
- Reinforced thumb saddle wear area
- Breathable poly mesh construction
- Low-profile molded hook and loop closure with ID
- Pull-on tab for easy on/off

ITEM #	SIZE	COLOR	ITEM #	SIZE	COLOR
17172	S	Black	17175	XL	Black
17173	M	Black	17176	2XL	Black
17174	L	Black			

// PATENT PENDING

812

ORDER MULTIPLE
1

UTILITY + CUT 5

- Armortex®-backed palm for Level 5 cut protection
- Reinforced thumb saddle wear area
- Breathable poly mesh construction
- Low-profile molded hook and loop closure with ID
- Pull-on tab for easy on/off

ITEM #	SIZE	COLOR	ITEM #	SIZE	COLOR
17182	S	Black	17185	XL	Black
17183	M	Black	17186	2XL	Black
17184	L	Black			

// PATENT PENDING

812

ORDER MULTIPLE
1

UTILITY + TOUCH

- Touch screen capable palm
- Reinforced thumb saddle wear area
- Breathable poly mesh construction
- Low-profile molded hook and loop closure with ID
- Pull-on tab for easy on/off

ITEM #	SIZE	COLOR	ITEM #	SIZE	COLOR
17192	S	Black	17195	XL	Black
17193	M	Black	17196	2XL	Black
17194	L	Black			

// PATENT PENDING

815

ORDER MULTIPLE
1

QUICKCUFF™ UTILITY

- Durable synthetic leather palm
- Reinforced thumb saddle wear area
- Breathable poly mesh construction
- QuickCuff™ elastic gauntlet fit with ID
- Pull-on tab for easy on/off

ITEM #	SIZE	COLOR	ITEM #	SIZE	COLOR
17202	S	Black	17205	XL	Black
17203	M	Black	17206	2XL	Black
17204	L	Black			

// PATENT PENDING

810

ORDER MULTIPLE
1

REINFORCED UTILITY

- Ultra-durable AX Suede™ palm reinforcement
- AX Suede™-reinforced thumb saddle wear area
- Breathable poly mesh construction
- Low-profile molded hook and loop closure with ID
- Pull-on tab for easy on/off

ITEM #	SIZE	COLOR	ITEM #	SIZE	COLOR
17222	S	Black	17225	XL	Black
17223	M	Black	17226	2XL	Black
17224	L	Black			

// PATENT PENDING

821

ORDER MULTIPLE
1

SMOOTH SURFACE HANDLING

- Hex silicone palm pattern for super-tacky grip
- Wrapped index finger for enhanced control
- Breathable poly mesh construction
- Low-profile molded hook and loop closure with ID
- Pull-on tab for easy on/off

ITEM #	SIZE	COLOR	ITEM #	SIZE	COLOR
17232	S	Black	17235	XL	Black
17233	M	Black	17236	2XL	Black
17234	L	Black			

// PATENT PENDING

860

ORDER MULTIPLE
1

LIFTING HANDLER

- Half-finger design for high dexterity
- Durable, split leather padded palm
- Stretch spandex with neoprene knuckle pad
- Terry thumb brow wipe
- Hook and loop closure

ITEM #	SIZE	COLOR	ITEM #	SIZE	COLOR
16122	S	Black	16125	XL	Black
16123	M	Black	16126	2XL	Black
16124	L	Black			

// PATENT PENDING

PROFLEX® GLOVES:

TRADES SERIES

DIFFERENTIATED BY DESIGN:

RUGGED REINFORCEMENTS

Tena-Grip™ reinforcement zones on palm, thumb saddle, and fingertips resist abrasion and provide superior grip on tools and equipment.

FULL OR FRAMING

Full-finger gloves offer maximum protection while a framing finger configuration combines protection with maximum dexterity for handling fasteners.



NEOPRENE KNUCKLE PAD

Padded neoprene knuckle area protects while providing maximum comfort.

PADDED PALM

Premium EVA foam palm pad helps dampen shock and impact.

TECHNICAL OPTIONS

Choose TX Touch Screen fingertips, Cut Level 5 protection, or genuine leather zones.

710CL5



FIND OUT MORE ABOUT THE TECHNOLOGY THAT GOES INTO THE FULL LINE OF ERGODYNE GLOVES AT: WWW.ERGODYNE.COM

			710			ORDER MULTIPLE 1																							
HEAVY DUTY UTILITY																													
<ul style="list-style-type: none"> • Padded palm with Tena-Grip™ reinforcement • Tena-Grip™-reinforced fingertips and thumb saddle • Technical hex-stretch material construction • Neoprene knuckle pad • Low-profile molded hook and loop closure with ID 																													
<table border="1"> <thead> <tr> <th>ITEM #</th> <th>SIZE</th> <th>COLOR</th> </tr> </thead> <tbody> <tr> <td>17042</td> <td>S</td> <td>Black</td> </tr> <tr> <td>17043</td> <td>M</td> <td>Black</td> </tr> <tr> <td>17044</td> <td>L</td> <td>Black</td> </tr> </tbody> </table>			ITEM #	SIZE	COLOR	17042	S	Black	17043	M	Black	17044	L	Black	<table border="1"> <thead> <tr> <th>ITEM #</th> <th>SIZE</th> <th>COLOR</th> </tr> </thead> <tbody> <tr> <td>17045</td> <td>XL</td> <td>Black</td> </tr> <tr> <td>17046</td> <td>2XL</td> <td>Black</td> </tr> </tbody> </table>			ITEM #	SIZE	COLOR	17045	XL	Black	17046	2XL	Black			
ITEM #	SIZE	COLOR																											
17042	S	Black																											
17043	M	Black																											
17044	L	Black																											
ITEM #	SIZE	COLOR																											
17045	XL	Black																											
17046	2XL	Black																											
// PATENT PENDING																													

			710 _{LTR}			ORDER MULTIPLE 1																							
HEAVY DUTY LEATHER-REINFORCED																													
<ul style="list-style-type: none"> • Padded palm with durable leather reinforcement • Leather fingertips, thumb, and thumb saddle • Technical hex-stretch material construction • Neoprene knuckle pad • Low-profile molded hook and loop closure with ID 																													
<table border="1"> <thead> <tr> <th>ITEM #</th> <th>SIZE</th> <th>COLOR</th> </tr> </thead> <tbody> <tr> <td>17142</td> <td>S</td> <td>Black</td> </tr> <tr> <td>17143</td> <td>M</td> <td>Black</td> </tr> <tr> <td>17144</td> <td>L</td> <td>Black</td> </tr> </tbody> </table>			ITEM #	SIZE	COLOR	17142	S	Black	17143	M	Black	17144	L	Black	<table border="1"> <thead> <tr> <th>ITEM #</th> <th>SIZE</th> <th>COLOR</th> </tr> </thead> <tbody> <tr> <td>17145</td> <td>XL</td> <td>Black</td> </tr> <tr> <td>17146</td> <td>2XL</td> <td>Black</td> </tr> </tbody> </table>			ITEM #	SIZE	COLOR	17145	XL	Black	17146	2XL	Black			
ITEM #	SIZE	COLOR																											
17142	S	Black																											
17143	M	Black																											
17144	L	Black																											
ITEM #	SIZE	COLOR																											
17145	XL	Black																											
17146	2XL	Black																											
// PATENT PENDING																													

710_{CL5}

ORDER MULTIPLE
1

HEAVY DUTY + CUT 5

EN388
TBA

NEW FOR
'16

- Armortex®-backed palm for Level 5 cut protection
- Padded palm with Tena-Grip™ reinforcement
- Technical hex-stretch material construction
- Neoprene knuckle pad
- Low-profile molded hook and loop closure with ID

ITEM #	SIZE	COLOR	ITEM #	SIZE	COLOR
17122	S	Black	17125	XL	Black
17123	M	Black	17126	2XL	Black
17124	L	Black			

// PATENT PENDING

710_{TX}

ORDER MULTIPLE
1

HEAVY DUTY + TOUCH

EN388
TBA

NEW FOR
'16

- Touch screen thumb and index finger reinforcement
- Padded palm with Tena-Grip™ reinforcement
- Technical hex-stretch material construction
- Neoprene knuckle pad
- Low-profile molded hook and loop closure with ID

ITEM #	SIZE	COLOR	ITEM #	SIZE	COLOR
17132	S	Black	17135	XL	Black
17133	M	Black	17136	2XL	Black
17134	L	Black			

// PATENT PENDING

720

ORDER MULTIPLE
1

HEAVY DUTY FRAMING

EN388
TBA

UPDATED FOR
'16

- Framing finger config for grasping fasteners
- Padded palm with Tena-Grip™ reinforcement
- Technical hex-stretch material construction
- Neoprene knuckle pad
- Low-profile molded hook and loop closure with ID

ITEM #	SIZE	COLOR	ITEM #	SIZE	COLOR
17112	S	Black	17115	XL	Black
17113	M	Black	17116	2XL	Black
17114	L	Black			

// PATENT PENDING

720_{LTR}

ORDER MULTIPLE
1

HEAVY DUTY LEATHER-REINFORCED FRAMING

EN388
TBA

NEW FOR
'16

- Framing finger config for grasping fasteners
- Padded palm with durable leather reinforcement
- Technical hex-stretch material construction
- Neoprene knuckle pad
- Low-profile molded hook and loop closure with ID

ITEM #	SIZE	COLOR	ITEM #	SIZE	COLOR
17152	S	Black	17155	XL	Black
17153	M	Black	17156	2XL	Black
17154	L	Black			

// PATENT PENDING

820

ORDER MULTIPLE
1

HIGH ABRASION HANDLING

EN388
TBA

UPDATED FOR
'16

- Abrasion resistant Tena-Grip™ palm and fingers
- Tena-Grip™-reinforced thumb saddle
- Technical hex-stretch material construction
- Neoprene knuckle pad
- Low-profile molded hook and loop closure with ID

ITEM #	SIZE	COLOR	ITEM #	SIZE	COLOR
17242	S	Black	17245	XL	Black
17243	M	Black	17246	2XL	Black
17244	L	Black			

// PATENT PENDING

840

ORDER MULTIPLE
1

LEATHER TRADES

- Split leather palm and fingertips
- Armortex®-reinforced thumb saddle
- Molded TPR finger protection
- Foam-padded palm; knuckle pad
- Elastic gauntlet fit cuff

ITEM #	SIZE	COLOR	ITEM #	SIZE	COLOR
16082	S	Black	16085	XL	Black
16083	M	Black	16086	2XL	Black
16084	L	Black			

PROFLEX® GLOVES:

FIRE & RESCUE SERIES

DIFFERENTIATED BY DESIGN:

ARMORTEX® REINFORCEMENTS

Rugged Armortex® zones on palm, thumb saddle, and fingers protect against cuts, scrapes, and abrasion.

DOUBLE-NEEDLE KEVLAR® STITCHING

Double-needle Kevlar® stitching found throughout the glove for extended life and maximum durability.

REFLECTIVE KNUCKLE PAD

EVA foam knuckle pad with reflective pattern provides both protection and visibility.

OUTDRY® BLOODBORNE PATHOGEN RESISTANCE

The 7300D features an OutDry® bonded waterproof membrane that also provides ASTM-certified bloodborne pathogen resistance.

ELASTIC GAITOR CUFF

Elastic cuff with gaitor inside keeps out glass and debris.



7300D



FIND OUT MORE ABOUT THE TECHNOLOGY THAT GOES INTO THE FULL LINE OF ERGODYNE GLOVES AT: WWW.ERGODYNE.COM

740

ORDER
MULTIPLE
1

FIRE & RESCUE ROPE

3343
EN388

- Double-layer synthetic leather palm and fingers
- Reinforced EVA-padded rope channel
- Double-needle Kevlar® stitching
- Stretch spandex shell for comfort and fit
- Adjustable wrist cinch anchor for extra security

ITEM #	SIZE	COLOR	ITEM #	SIZE	COLOR
17802	S	Black	17805	XL	Black
17803	M	Black	17806	2XL	Black
17804	L	Black			

730

ORDER
MULTIPLE
1

PERFORMANCE FIRE & RESCUE

4243
EN388

- Rugged Armortex®-reinforced palm & thumb saddle
- Reinforced fingertip gripping zones; EVA palm pad
- Double-needle Kevlar® stitching
- Stretch spandex shell for comfort and fit
- EVA knuckle pad with reflective pattern

ITEM #	SIZE	COLOR	ITEM #	SIZE	COLOR
16362	S	HV Lime	16382	S	Black
16363	M	HV Lime	16383	M	Black
16364	L	HV Lime	16384	L	Black
16365	XL	HV Lime	16385	XL	Black
16366	2XL	HV Lime	16386	2XL	Black

730₀₀

ORDER
MULTIPLE
1

PERFORMANCE FIRE & RESCUE OUTDRY®

4243
EN388

- Waterproof OutDry® membrane passes ASTM F1670, 71
- Compliant protection to OSHA 29CFR 1910.1030
- Rugged Armortex®-reinforced palm & thumb saddle
- Reinforced fingertip gripping zones; EVA palm pad
- Stretch spandex shell for comfort and fit

ITEM #	SIZE	COLOR	ITEM #	SIZE	COLOR
17102	S	HV Lime	17105	XL	HV Lime
17103	M	HV Lime	17106	2XL	HV Lime
17104	L	HV Lime			

BLOOD IS THICKER THAN WATER. OUTDRY® STOPS 'EM BOTH.

The ProFlex® 7300D with OutDry® is 3rd party tested to ASTM 1670, the standard for synthetic blood penetration. The OutDry® membrane passes the ASTM 1671 test for surrogate microbe penetration to protect from harmful disease-causing pathogens, providing protection compliant with Federal Rule 29CFR 1910.1030 that addresses occupational exposure to blood or other potentially infectious materials.



CLEAN, WHITE LINER



60 MINUTE SYNTHETIC BLOOD IMMERSION



CLEAN, WHITE LINER: **TEST PASSED**

PROFLEX® GLOVES:

THERMAL SERIES

DIFFERENTIATED BY DESIGN:

REINFORCED PALMS

Durable, abrasion-resistant palm, thumb saddle, and fingertip reinforcements provide grip and slip-resistance in chilly temps.

TERRY THUMB WIPE

Soft terry thumbs provide a comfortable place for wiping brows...or noses. Hey, it's cold outside!

3M™ THINSULATE™ INSULATION

3M™ Thinsulate™ insulation utilizes uniquely thin microfibers to trap more air, keeping workers' hands warmer in even the coldest applications.

PULL TABS

Convenient pull tabs allow for easy on/off.

WATERPROOF TECHNOLOGY

Choose a breathable waterproof insert or bonded OutDry® technology to keep hands dry when Mother Nature has other ideas.



8190D



FIND OUT MORE ABOUT THE TECHNOLOGY THAT GOES INTO THE FULL LINE OF ERGODYNE GLOVES AT: WWW.ERGODYNE.COM



819.00

ORDER MULTIPLE 1

THERMAL WATERPROOF GAUNTLET OUTDRY®



121 EN511



4223 EN388

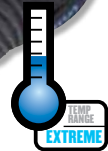

- 40g 3M™ Thinsulate™ insulation
- OutDry® waterproof, windproof bonded membrane
- Abrasion-resistant reinforced palm and fingertips
- 500D nylon back and gauntlet cuff and pull-on tab
- EVA knuckle pad with reflective pattern

ITEM #	SIZE	COLOR	ITEM #	SIZE	COLOR
16472	S	Black	16475	XL	Black
16473	M	Black	16476	2XL	Black
16474	L	Black			

// PATENTED



818.00

ORDER MULTIPLE 1

THERMAL WATERPROOF UTILITY OUTDRY®



- 40g 3M™ Thinsulate™ insulation
- OutDry® waterproof, windproof bonded membrane
- Abrasion-resistant reinforced palm and fingertips
- Breathable spandex back with foam knuckle pad
- Neoprene cuff with hook and loop closure

ITEM #	SIZE	COLOR	ITEM #	SIZE	COLOR
16462	S	Black	16465	XL	Black
16463	M	Black	16466	2XL	Black
16464	L	Black			

// PATENTED

819_{WP}

ORDER
MULTIPLE
1

THERMAL WATERPROOF GAUNTLET

- 40g 3M™ Thinsulate™ insulation
- Water and windproof, breathable insert liner
- Abrasion-resistant reinforced palm and fingertips
- 500D nylon back and gauntlet cuff and pull-on tab
- EVA knuckle pad with reflective pattern

ITEM #	SIZE	COLOR	ITEM #	SIZE	COLOR
16042	S	Black	16045	XL	Black
16043	M	Black	16046	2XL	Black
16044	L	Black			

818_{WP}

ORDER
MULTIPLE
1

THERMAL WATERPROOF UTILITY

111
EN511

4122
EN388

- 40g 3M™ Thinsulate™ insulation
- Water and windproof, breathable insert liner
- Abrasion-resistant reinforced palm and fingertips
- Breathable spandex back with foam knuckle pad
- Neoprene cuff with hook and loop closure

ITEM #	SIZE	COLOR	ITEM #	SIZE	COLOR
16032	S	Black	16035	XL	Black
16033	M	Black	16036	2XL	Black
16034	L	Black			

876_{WP}

ORDER
MULTIPLE
1

HI-VIS THERMAL WATERPROOF

- 40g 3M™ Thinsulate™ insulation
- Water and windproof, breathable insert liner
- Abrasion-resistant reinforced palm and fingertips
- Hi-vis shell with 3M™ Scotchlite™ reflective zones
- Neoprene cuff with low-profile hook and loop closure

ITEM #	SIZE	COLOR	ITEM #	SIZE	COLOR
16412	S	HV Orange	16415	XL	HV Orange
16413	M	HV Orange	16416	2XL	HV Orange
16414	L	HV Orange			

817_{WP}

ORDER
MULTIPLE
1

THERMAL UTILITY

- 40g 3M™ Thinsulate™ insulation
- Water and windproof, breathable insert liner
- Double-reinforced synthetic leather palm
- Padded spandex back and neoprene knuckle pad
- Low-profile hook and loop closure with pull-on tab

ITEM #	SIZE	COLOR	ITEM #	SIZE	COLOR
16022	S	Black	16025	XL	Black
16023	M	Black	16026	2XL	Black
16024	L	Black			

817

ORDER
MULTIPLE
1

THERMAL UTILITY

- 40g 3M™ Thinsulate™ insulation
- Double reinforced synthetic leather palm
- Padded spandex back and neoprene knuckle pad
- Low-profile hook and loop closure with pull-on tab
- Terry thumb brow wipe

ITEM #	SIZE	COLOR	ITEM #	SIZE	COLOR
16332	S	Black	16335	XL	Black
16333	M	Black	16336	2XL	Black
16334	L	Black			

816

ORDER
MULTIPLE
1

THERMAL FLIP-TOP

- Flip-top fingers secured with hook and loop tabs
- Durable polyester knit with warming pack pocket
- Windproof, water-repellent micro fleece inside
- Double-layer palm with anti-slip grip
- Soft, polyester fleece cuff

ITEM #	SIZE	COLOR	ITEM #	SIZE	COLOR
16072	S	Black	16075	XL	Black
16073	M	Black	16076	2XL	Black
16074	L	Black			

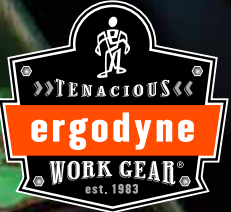

PROFLEX[®] KNEE PADS

**YOUR GIG IS ABOUT TO GET
A WHOLE LOT CUSHIER.**





PROFLEX® KNEE PADS

Want a cushy gig? The kind of gig that doesn't wear you out, wear you down, and suck all your vim and verve? We are happy to provide. Turn any task that could be gnarly on your knees into a patella-pleasure-cruise with ProFlex® Knee and Kneeling Pads. You'll be able to endure even the most grueling task without sacrificing your ability to stand up straight the next day. And you don't even have to be the boss's nephew.

KNEE PADS // GEL SERIES



342 Extra Long Cap Injected Gel



344 Broad Cap Injected Gel



345 Long Cap Injected Gel



355 Short Cap Injected Gel

KNEE PADS // STANDARD SERIES



300 Rounded Hard Cap



315 Long Textured Hard Cap



325 Non-Marring Rubber Cap



335 Slip-Resistant Rubber Cap

KNEE PADS // KNEELING PAD SERIES



375 Compact



380 Standard



385 Large



390 Extra Large



347 Long Cap Lightweight Gel



349 Broad Cap Lightweight Gel



357 Short Cap Lightweight Gel



367 Low-Profile Lightweight Gel



350 Gel Foam



340 Slip-Resistant w/ Shin Pad



200 Copolymer Foam



210 Copolymer Hard Cap



230 Poly Cap



260 Slip-On Cloth

PROFLEX® KNEE PADS:

GEL SERIES

DIFFERENTIATED BY DESIGN:

GEL OPTIONS

Choose injected gel for rugged, all-day cushioning or light-weight gel for highly mobile comfort.

INNOVATIVE CAP DESIGN

Unique cap design distributes the weight across the entire knee, relieving direct pressure on the patella for more comfortable kneeling.

UNIQUE STRAP STYLES

Different straps do different things: sometimes they're designed to deliver a secure fit, sometimes to relieve discomfort on the back of your knee. Take a look, you're sure to find a configuration tailored for you.



			342	ORDER MULTIPLE 1						
<p>EXTRA LONG CAP INJECTED GEL</p>  <ul style="list-style-type: none"> • 100% injected gel and PU foam for all day comfort • Unique fastening system, no straps behind knee • Patented suspension cap • Delivers stability on all terrain surfaces • Extended shin protection optimizes stability <table border="1"> <thead> <tr> <th>ITEM #</th> <th>SIZE</th> <th>COLOR</th> </tr> </thead> <tbody> <tr> <td>18343</td> <td>—</td> <td>Black</td> </tr> </tbody> </table> <p>// PATENTED</p>					ITEM #	SIZE	COLOR	18343	—	Black
ITEM #	SIZE	COLOR								
18343	—	Black								

			344	ORDER MULTIPLE 1						
<p>BROAD CAP INJECTED GEL</p>  <ul style="list-style-type: none"> • 100% injected gel and PU foam for all day comfort • Patented suspension cap • Broad cap disperses weight and maintains stability • Padded upper and lower straps on the thigh and calf • Stitched-in plastic clip adjustment <table border="1"> <thead> <tr> <th>ITEM #</th> <th>SIZE</th> <th>COLOR</th> </tr> </thead> <tbody> <tr> <td>18344</td> <td>—</td> <td>Black</td> </tr> </tbody> </table> <p>// PATENTED</p>					ITEM #	SIZE	COLOR	18344	—	Black
ITEM #	SIZE	COLOR								
18344	—	Black								

			345	ORDER MULTIPLE 1						
<p>LONG CAP INJECTED GEL</p>  <ul style="list-style-type: none"> • 100% injected gel and PU foam for all day comfort • Patented suspension cap • Long cap design provides full coverage protection • 3-strap design: two bottom webbing and top elastic • Stitched-in plastic clip adjustment <table border="1"> <thead> <tr> <th>ITEM #</th> <th>SIZE</th> <th>COLOR</th> </tr> </thead> <tbody> <tr> <td>18346</td> <td>—</td> <td>Black</td> </tr> </tbody> </table> <p>// PATENTED</p>					ITEM #	SIZE	COLOR	18346	—	Black
ITEM #	SIZE	COLOR								
18346	—	Black								

PROFLEX[®] KNEE PAD GEL TECHNOLOGY

INJECTED GEL TECHNOLOGY (342, 344, 345, 355)

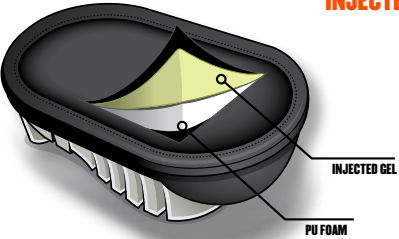

INJECTED GEL PROVIDES:
 Increased Wearer Comfort
 Improved Worker Productivity (Work longer in great comfort)
 Enhanced Knee Pad Durability (Gel does not slide and wear)

LIGHTWEIGHT GEL TECHNOLOGY (347, 349, 357, 367)

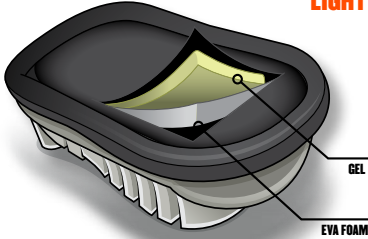

LIGHTWEIGHT GEL PROVIDES:
 Reduced Wearer Fatigue
 Lightweight Comfort
 Gel Performance at an Exceptional Value



FIND OUT MORE ABOUT THE TECHNOLOGY THAT GOES INTO THE FULL LINE OF ERGODYNE KNEE PROTECTION AT: WWW.ERGODYNE.COM

			347	ORDER MULTIPLE 1	
<h3>LONG CAP LIGHTWEIGHT GEL</h3>					
					
<ul style="list-style-type: none"> • Lightweight gel and EVA foam for mobile comfort • Patented suspension cap • Long cap design provides full coverage protection • Bottom webbing and top elastic straps • Stitched-in plastic clip adjustment 					
ITEM #	SIZE	COLOR			
18348	—	Black			
// PATENTED					

			349	ORDER MULTIPLE 1	
<h3>BROAD CAP LIGHTWEIGHT GEL</h3>					
					
<ul style="list-style-type: none"> • Lightweight gel and EVA foam for mobile comfort • Patented suspension cap • Broad cap disperses weight and maintains stability • Bottom webbing and top elastic straps • Stitched-in plastic clip adjustment 					
ITEM #	SIZE	COLOR			
18349	—	Black			
// PATENTED					

			355	ORDER MULTIPLE 1	
<h3>SHORT CAP INJECTED GEL</h3>					
					
<ul style="list-style-type: none"> • 100% injected gel and PU foam for all day comfort • Patented suspension cap • Innovative short cap allows rocking and leaning • Bottom webbing and top elastic straps • Stitched-in plastic clip adjustment 					
ITEM #	SIZE	COLOR			
18356	—	Black			
// PATENTED					

			357	ORDER MULTIPLE 1	
<h3>SHORT CAP LIGHTWEIGHT GEL</h3>					
					
<ul style="list-style-type: none"> • Lightweight gel and EVA foam for mobile comfort • Patented suspension cap • Innovative cap shape allows rocking and leaning • Bottom webbing and top elastic straps • Stitched-in plastic clip adjustment 					
ITEM #	SIZE	COLOR			
18358	—	Black			
// PATENTED					

			367	ORDER MULTIPLE 1	
<h3>LOW-PROFILE LIGHTWEIGHT GEL</h3>					
					
<ul style="list-style-type: none"> • Lightweight gel and EVA foam for mobile comfort • Low-profile cap allows for rocking and leaning • Grooved cap design for added grip • Bottom webbing and top elastic straps • Stitched-in plastic clip adjustment 					
ITEM #	SIZE	COLOR			
18368	—	Black			

			350	ORDER MULTIPLE 1	
<h3>GEL FOAM</h3>					
					
<ul style="list-style-type: none"> • 12mm NBR gel padding & 20mm EVA padding • 1680D ballistic nylon outer shell • Slip-resistant durable 420D nylon-rubber surface • Adjustable, breathable neoprene stretch strap • Hook and loop closure 					
ITEM #	SIZE	COLOR			
18350	—	Black			

PROFLEX® KNEE PAD SELECT-O-MATIC

A handy little chart to help you pick the pad you kneed.

MODEL	SERIES	CAP TYPE	CUSHIONING TYPE	CLOSURE TYPE	ACTION // FUNCTION
200	Standard	Copolymer Foam	Copolymer Foam	Hook & Loop	Super lightweight economy style for workers who need to kneel occasionally and don't want to pay the price
210	Standard	Plastic		Hook & Loop	Hard cap for kneeling on hard or rough surfaces at an economy price
230	Standard	Polyester Fabric	RB Foam	Buckle	Fabric cap for kneeling on delicate surfaces
230HL	Standard			Hook & Loop	
260	Standard	Tricot Fabric	EVA Foam	Slip-On	Easy slip-on, slip-off style that fits under work pants
300	Standard	Short Rounded Polypropylene Plastic	NBR Foam	Buckle	Rounded hard cap for pivoting, swiveling, rocking, and sliding
300HL	Standard			Hook & Loop	
315	Standard	Long Polypropylene Plastic		Buckle	Long hard cap for pivoting, rocking, and sliding where additional knee protection is desired
315HL	Standard			Hook & Loop	
325	Standard	Long Non-Marring TPR Rubber		Buckle	Rubber cap for kneeling on delicate surfaces
325HL	Standard			Hook & Loop	
335	Standard	Long Slip Resistant TPR Rubber		Buckle	Grips well on both wet or dry work surfaces. Protects knees against rock and debris on rough surfaces. Allows the worker to rock and lean without slipping.
335HL	Standard			Hook & Loop	
340	Standard	Long Slip Resistant TPR Rubber with Shin Pad		Buckle	
342	Gel	Extra Long TPE Rubber		Injected Gel & PU Foam	Buckle
344	Gel	Broad TPE Rubber			
345	Gel	Long TPE Rubber			
355	Gel	Short TPE Rubber			
349	Gel	Broad TPE Rubber	Lightweight Gel & EVA Foam	Lightweight gel for mobile comfort. For the worker that wants less weight when walking around but still have gel comfort. Different size and style TPE caps depending on job task for kneeling on all types of terrain.	
347	Gel	Long TPE Rubber			
357	Gel	Short TPE Rubber			
367	Gel	Low Profile TPE Rubber			
350	Gel	Nylon and Neoprene Fabric	NBR & EVA Gel Foam	Hook & Loop	Superior cushioning with fabric cap to kneel on delicate as well as hard or rough surfaces.

PROFLEX® KNEE PADS:

STANDARD SERIES

DIFFERENTIATED BY DESIGN:

CLOSURE OPTIONS

Select non-marring hook and loop closures or infinitely variable buckles that will not snag on carpet or pick up grime. Both closures adjust quickly for a comfortable fit.

MULTIPLE CAP STYLES

Choose the right cap for the application. Whether you want to rock, lean, slide, or stay stable, there are many cap sizes and shapes to choose from.

NBR FOAM PADDING

Inside the 840D nylon fabric cover is 12mm NBR foam padding cut to hug the knee for superior cushioning and kneeling comfort.



300HL

			300	ORDER MULTIPLE 1	
ROUNDED HARD CAP					
<ul style="list-style-type: none"> • Abrasion-resistant rounded short hard cap • 840D nylon fabric cover • 12mm NBR foam padding cut to hug the knee • Nickel-plated grommets • Buckle or hook and loop closure 					
300: BUCKLE		300HL: HOOK AND LOOP			
ITEM #	SIZE	COLOR	ITEM #	SIZE	COLOR
18300	—	White Cap	18301	—	White Cap

			315	ORDER MULTIPLE 1	
LONG TEXTURED HARD CAP					
<ul style="list-style-type: none"> • Abrasion-resistant long hard cap • 840D nylon fabric cover • 12mm NBR foam padding cut to hug the knee • Nickel-plated grommets • Buckle or hook and loop closure 					
315: BUCKLE		315HL: HOOK AND LOOP			
ITEM #	SIZE	COLOR	ITEM #	SIZE	COLOR
18315	—	White Cap	18316	—	White Cap

			325	ORDER MULTIPLE 1	
NON-MARRING RUBBER CAP					
<ul style="list-style-type: none"> • Non-marring long cap • 840D nylon fabric cover • 12mm NBR foam padding cut to hug the knee • Nickel-plated grommets • Buckle or hook and loop closure 					
325: BUCKLE		325HL: HOOK AND LOOP			
ITEM #	SIZE	COLOR	ITEM #	SIZE	COLOR
18325	—	Tan Cap	18326	—	Tan Cap

335

ORDER MULTIPLE
1

SLIP RESISTANT RUBBER CAP



- Slip-resistant long rubber cap to grip surfaces
- 840D nylon fabric cover
- 12mm NBR foam padding cut to hug the knee
- Nickel-plated grommets
- Buckle or hook and loop closure

335: BUCKLE

ITEM #	SIZE	COLOR
18335	—	Black Cap

335HL: HOOK AND LOOP

ITEM #	SIZE	COLOR
18336	—	Black Cap

340

ORDER MULTIPLE
1

SLIP RESISTANT RUBBER CAP W/ SHIN GUARD



- Slip-resistant long rubber cap to grip surfaces
- 840D nylon fabric cover with tapered shin guard
- 12mm NBR foam padding cut to hug the knee
- Nickel-plated grommets
- Buckle closure

ITEM #	SIZE	COLOR
18340	—	Black Cap

200

ORDER MULTIPLE
1

SHORT LIGHT DUTY COPOLYMER



- Durable copolymer padding
- Super lightweight for comfortable all day wear
- Single strap with hook and loop closure

ITEM #	SIZE	COLOR
18200	—	Black

210

ORDER MULTIPLE
1

LONG COPOLYMER HARD CAP



- Hard cap cover with durable copolymer padding
- CoolMax[®] liner for dry comfort
- Flame laminated inner sponge for added comfort
- Two straps with hook and loop closure

ITEM #	SIZE	COLOR
18210	—	Black

230

ORDER MULTIPLE
1

WIDE SOFT CAP



- Durable 600D polyester fabric cover
- 15mm closed cell foam padding
- Slightly wider and longer for wraparound comfort
- Anti-odor treatment
- Buckle or hook and loop closure

230: BUCKLE

ITEM #	SIZE	COLOR
18230	—	Black

230HL: HOOK AND LOOP

ITEM #	SIZE	COLOR
18231	—	Black

260

ORDER MULTIPLE
1

SOFT SLIP-ON



- Lightweight, slip-on knee pads
- Soft outer cloth and foam padding
- Woven elastic sleeve for easy on and off
- Wear over or under clothing

ITEM #	SIZE	COLOR
18260	—	Black

PROFLEX® KNEELING PADS:

KNEELING PAD SERIES

DIFFERENTIATED BY DESIGN:

NBR FOAM

Made from high density NBR foam that won't bottom out for long-lasting support and comfort.

BEVELED EDGE AND SAFETY ORANGE STRIPING

Beveled edge and safety orange striping on certain models for visibility of the worker and kneeling pad.

PETROLEUM RESISTANT AND SILICONE-FREE

High-quality foam will not break down in the harshest of applications; silicone-free allows for safe, non-corrosive usage.

CONVENIENT HANDLE

Handle cut-out for easy carrying and convenient for hanging storage.



	375	ORDER MULTIPLE 1						
<p>COMPACT KNEELING PAD</p> <div style="text-align: center; margin: 20px 0;"> </div> <ul style="list-style-type: none"> Compact size for optimal portability Convenient handle also allows for hanging storage 8" x 18" x 1" (20cm x 46cm x 2.5cm) Fits in the Arsenal® 5845 Trades Tool Organizer <table border="1" style="width: 100%; border-collapse: collapse; margin-top: 20px;"> <thead> <tr> <th style="text-align: left;">ITEM #</th> <th style="text-align: left;">SIZE</th> <th style="text-align: left;">COLOR</th> </tr> </thead> <tbody> <tr> <td>18376</td> <td>—</td> <td>Orange</td> </tr> </tbody> </table>			ITEM #	SIZE	COLOR	18376	—	Orange
ITEM #	SIZE	COLOR						
18376	—	Orange						

	380	ORDER MULTIPLE 1									
<p>STANDARD KNEELING PAD</p> <div style="text-align: center; margin: 20px 0;"> </div> <ul style="list-style-type: none"> Standard size for optimal portability Convenient handle also allows for hanging storage 14" x 21" x 1" (36cm x 53cm x 2.5cm) Available in black and orange <table border="1" style="width: 100%; border-collapse: collapse; margin-top: 20px;"> <thead> <tr> <th style="text-align: left;">ITEM #</th> <th style="text-align: left;">SIZE</th> <th style="text-align: left;">COLOR</th> </tr> </thead> <tbody> <tr> <td>18380</td> <td>—</td> <td>Black</td> </tr> <tr> <td>18381</td> <td>—</td> <td>Orange</td> </tr> </tbody> </table>			ITEM #	SIZE	COLOR	18380	—	Black	18381	—	Orange
ITEM #	SIZE	COLOR									
18380	—	Black									
18381	—	Orange									

	385	ORDER MULTIPLE 1						
<p>LARGE KNEELING PAD</p> <div style="text-align: center; margin: 20px 0;"> </div> <ul style="list-style-type: none"> Larger work surface Beveled safety edge with orange warning stripes Convenient handle also allows for hanging storage 16" x 28" x 1" (41cm x 71cm x 2.5cm) <table border="1" style="width: 100%; border-collapse: collapse; margin-top: 20px;"> <thead> <tr> <th style="text-align: left;">ITEM #</th> <th style="text-align: left;">SIZE</th> <th style="text-align: left;">COLOR</th> </tr> </thead> <tbody> <tr> <td>18385</td> <td>—</td> <td>Black</td> </tr> </tbody> </table>			ITEM #	SIZE	COLOR	18385	—	Black
ITEM #	SIZE	COLOR						
18385	—	Black						

	390	ORDER MULTIPLE 1						
<p>EXTRA LARGE KNEELING PAD</p> <div style="text-align: center; margin: 20px 0;"> </div> <ul style="list-style-type: none"> Larger work surface Beveled safety edge with orange warning stripes Convenient handle also allows for hanging storage 18" x 36" x 1" (46cm x 91cm x 2.5cm) <table border="1" style="width: 100%; border-collapse: collapse; margin-top: 20px;"> <thead> <tr> <th style="text-align: left;">ITEM #</th> <th style="text-align: left;">SIZE</th> <th style="text-align: left;">COLOR</th> </tr> </thead> <tbody> <tr> <td>18390</td> <td>—</td> <td>Black</td> </tr> </tbody> </table>			ITEM #	SIZE	COLOR	18390	—	Black
ITEM #	SIZE	COLOR						
18390	—	Black						

PROFLEX® KNEELING PAD SELECT-O-MATIC

A handy little chart to help you size up the situation.



PROFLEX[®] SUPPORTS

**BACK IN THE SADDLE.
IF YOUR SADDLE IS
CUTTING PIPE.**



PROFLEX® SUPPORTS

You're haulin' sixteen tons and what do you get? A slipped disc and three weeks bed rest. No dice. That's unacceptable from where we stand. Slip into ProFlex® comfort and security next time you're tasked with carrying the weight of the world. We've led the way in support technologies and innovation for thirty years. So allow us to ease your burden and get one over on the company store.

SUPPORTS // BACK SUPPORT SERIES



2000SF Performance Spandex



1100SF Standard Spandex



100 Economy Spandex



1400UN Universal Fit Spandex

SUPPORTS // WRIST SUPPORT SERIES



4000 Single Strap



4010 Double Strap



4020 Lightweight



670 Single Strap Ambi

SUPPORTS // WRAPS & SLEEVES SERIES



400 Wrist Wrap



420 Wrist Wrap w/ Thumb Loop



500 Elbow Wrap



600 Knee Sleeve



1051 Mesh w/ Lumbar Pad



1600 Standard Elastic



1650 Economy Elastic



1500 Weight Lifters



1505 Low-Profile Weight Lifters



675 Double Strap Ambi



615 Open Knee Sleeve



620 Knee Sleeve w/ Stays



650 Elbow Sleeve



655 Elbow Sleeve w/ Strap

PROFLEX® SUPPORTS:

BACK SUPPORT SERIES

DIFFERENTIATED BY DESIGN:

V-SHAPED DESIGN

V-shaped design helps support the natural shape of the human body for better fit and ultimately better effectiveness.

POWER PANEL POSITIONERS™

Innovative positioners keep the power panels in place so they are ready to be activated when needed and do not cause a hazard hanging behind the wearer.

STICKY FINGERS® STAYS

Patented Sticky Fingers® stays help keep the back support in position.



2000SF

			1100 ^{SF}			ORDER MULTIPLE 1
STANDARD SPANDEX BACK SUPPORT						
<ul style="list-style-type: none"> • 8" premium durable 280D spandex body material • Patented non-conductive Sticky Fingers® stays • Innovative Power Panel Positioners™ • Stretchable bias binding with zig-zag stitching • Adjustable, detachable suspenders 						
ITEM #	SIZE	COLOR	ITEM #	SIZE	COLOR	
11601	XS	Black	11605	XL	Black	
11602	S	Black	11606	2XL	Black	
11603	M	Black	11607	3XL	Black	
11604	L	Black	11608	4XL	Black	
// PATENTED						

			100			ORDER MULTIPLE 1
ECONOMY SPANDEX BACK SUPPORT						
<ul style="list-style-type: none"> • 8" economical spandex body • Non-conductive polypropylene stays • 280D spandex body material • Adjustable, detachable suspenders • Rubber track webbing 						
ITEM #	SIZE	COLOR	ITEM #	SIZE	COLOR	
11381	XS	Black	11385	XL	Black	
11382	S	Black	11386	2XL	Black	
11383	M	Black	11387	3XL	Black	
11384	L	Black	11388	4XL	Black	

			100 ^{HV}			ORDER MULTIPLE 1
ECONOMY HI-VIS SPANDEX BACK SUPPORT						
<ul style="list-style-type: none"> • 8" economical high visibility spandex body • Non-conductive polypropylene stays • Adjustable, detachable suspenders • Rubber track webbing • Stretchable bias binding with zig-zag stitching 						
ITEM #	SIZE	COLOR	ITEM #	SIZE	COLOR	
11881	XS	HV Orange	11885	XL	HV Orange	
11882	S	HV Orange	11886	2XL	HV Orange	
11883	M	HV Orange	11887	3XL	HV Orange	
11884	L	HV Orange	11888	4XL	HV Orange	

			2000 ^{SF}			ORDER MULTIPLE 1
HIGH PERFORMANCE SPANDEX BACK SUPPORT						
<ul style="list-style-type: none"> • 8.5" 840D spandex body material • Patented non-conductive Sticky Fingers® stays • Innovative Power Panel Positioners™ • Unique V-shaped design • Adjustable, detachable suspenders 						
ITEM #	SIZE	COLOR	ITEM #	SIZE	COLOR	
11281	XS	Black	11285	XL	Black	
11282	S	Black	11286	2XL	Black	
11283	M	Black	11287	3XL	Black	
11284	L	Black	11288	4XL	Black	
// PATENTED						

1400

ORDER MULTIPLE
1

UNIVERSAL SIZE BACK SUPPORT



- 8.75" durable 280D spandex body material
- Universal size: fits most waists
- Non-conductive polypropylene stays
- Adjustable, detachable suspenders
- Rubber track webbing

ITEM #	SIZE	COLOR
11400	—	Black

1600

ORDER MULTIPLE
1

STANDARD ELASTIC BACK SUPPORT



- 9" premium all-elastic body for extra firm support
- Contoured high-cut front panel
- Non-conductive polypropylene stays
- Adjustable, detachable suspenders
- Rubber track webbing

ITEM #	SIZE	COLOR	ITEM #	SIZE	COLOR
11101	XS	Black	11105	XL	Black
11102	S	Black	11106	2XL	Black
11103	M	Black	11107	3XL	Black
11104	L	Black	11108	4XL	Black

1650

ORDER MULTIPLE
1

ECONOMY ELASTIC BACK SUPPORT



- 7.5" economical all-elastic body
- 5" (12.7cm) single strap closure
- Non-conductive polypropylene stays
- Adjustable, detachable suspenders
- Rubber track webbing

ITEM #	SIZE	COLOR	ITEM #	SIZE	COLOR
11091	XS	Black	11095	XL	Black
11092	S	Black	11096	2XL	Black
11093	M	Black	11097	3XL	Black
11094	L	Black	11098	4XL	Black

1051

ORDER MULTIPLE
1

MESH BACK SUPPORT WITH LUMBAR PAD



- 10" breathable mesh outer shell
- Innovative Power Panel Positioners™
- Contoured ventilated lumbar pad
- Two-stage closure

ITEM #	SIZE	COLOR	ITEM #	SIZE	COLOR
20183	S	Black	20186	XL	Black
20184	M	Black	20187	2XL	Black
20185	L	Black			

1500

ORDER MULTIPLE
1

STANDARD WEIGHT LIFTERS STYLE BACK SUPPORT



- 7.75" rigid foam body
- Durable 900D foam laminated nylon body fabric
- Foam lumbar pad

ITEM #	SIZE	COLOR	ITEM #	SIZE	COLOR
11471	S	Black	11474	XL	Black
11472	M	Black	11475	2XL	Black
11473	L	Black			

1505

ORDER MULTIPLE
1

LOW-PROFILE WEIGHT LIFTERS STYLE BACK SUPPORT



- 6.25" low-profile tapered design
- Flexible soft foam core composition
- Nylon jersey body fabric
- Easy cam buckle closure system
- Rubber track webbing

ITEM #	SIZE	COLOR	ITEM #	SIZE	COLOR
11491	S	Black	11494	XL	Black
11492	M	Black	11495	2XL	Black
11493	L	Black			

PROFLEX® SUPPORTS:

WRIST SUPPORT SERIES

DIFFERENTIATED BY DESIGN:

ANTI-ODOR TREATMENT

Body-side surfaces are treated to eliminate odor-causing bacterial growth.

OPEN-CENTER STAY™

Patented design includes open center to reduce pressure on median nerve while the contoured design follows the wrist's natural shape.

ELASTIC OR NEOPRENE CONSTRUCTION

Depending on how much support is needed, choose between neoprene or woven elastic wrist supports with straps that limit flexion or extension movements.

4000



FIND OUT MORE ABOUT THE TECHNOLOGY THAT GOES INTO THE FULL LINE OF ERGODYNE WRAPS & SUPPORTS AT: WWW.ERGODYNE.COM



4000

ORDER MULTIPLE
1

SINGLE STRAP WRIST SUPPORT

- Limits downward wrist movements
- Patented Open-Center Stay™
- Single strap; elastic
- Three-stage hook and loop closure
- Anti-odor treatment

ITEM #	SIZE	COLOR	ITEM #	SIZE	COLOR
70002	S-Right	Black	70102	S-Right	Tan
70004	M-Right	Black	70104	M-Right	Tan
70006	L-Right	Black	70106	L-Right	Tan
70008	XL-Right	Black	70108	XL-Right	Tan
70012	S-Left	Black	70112	S-Left	Tan
70014	M-Left	Black	70114	M-Left	Tan
70016	L-Left	Black	70116	L-Left	Tan
70018	XL-Left	Black	70118	XL-Left	Tan

// PATENTED

4010

ORDER MULTIPLE
1

DOUBLE STRAP WRIST SUPPORT

- Limits downward and upward wrist movements
- Patented Open-Center Stay™
- Double strap; elastic
- Three-stage hook and loop closure
- Anti-odor treatment

ITEM #	SIZE	COLOR	ITEM #	SIZE	COLOR
70022	S-Right	Black	70122	S-Right	Tan
70024	M-Right	Black	70124	M-Right	Tan
70026	L-Right	Black	70126	L-Right	Tan
70028	XL-Right	Black	70128	XL-Right	Tan
70032	S-Left	Black	70132	S-Left	Tan
70034	M-Left	Black	70134	M-Left	Tan
70036	L-Left	Black	70136	L-Left	Tan
70038	XL-Left	Black	70138	XL-Left	Tan

// PATENTED

4020

ORDER MULTIPLE
1

LIGHTWEIGHT WRIST SUPPORT

- Lightweight, vented, compact design
- Patented Open-Center Stay™
- Neoprene
- Hook and loop closure

ITEM #	SIZE	COLOR	ITEM #	SIZE	COLOR
70202	XS/S-Right	Black	70282	XS/S-Left	Gray
70204	M-Right	Black	70284	M-Left	Gray
70206	L/XL-Right	Black	70286	L/XL-Left	Gray
70208	2XL-Right	Black	70288	2XL-Left	Gray
70242	XS/S-Left	Black	70292	XS/S-Right	Gray
70244	M-Left	Black	70294	M-Right	Gray
70246	L/XL-Left	Black	70296	L/XL-Right	Gray
70248	2XL-Left	Black	70298	2XL-Right	Gray

// PATENTED

670

ORDER MULTIPLE
1

SINGLE STRAP AMBI WRIST SUPPORT

- Neoprene
- Ambidextrous
- Reversible hook and loop strap

ITEM #	SIZE	COLOR
16612	S	Black
16613	M	Black
16614	L	Black
16615	XL	Black

675

ORDER MULTIPLE
1

DOUBLE STRAP AMBI WRIST SUPPORT

- Neoprene
- Ambidextrous
- Two reversible hook and loop straps

ITEM #	SIZE	COLOR
16622	S	Black
16623	M	Black
16624	L	Black
16625	XL	Black

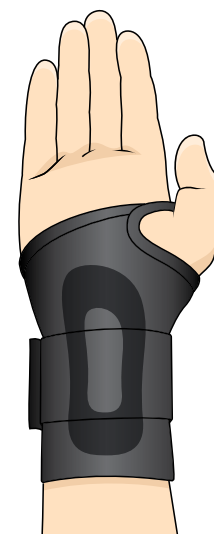

PATENTED OPEN-CENTER STAY™

Unlike traditional stay configurations positioned directly over the carpal tunnel, our stay is uniquely designed with an open center to reduce pressure on the median nerve. With a contoured design that follows the wrist's natural shape, the patented, molded stay offers greater worker comfort and compliance.

PROFLEX® SUPPORTS:

WRAPS & SLEEVES SERIES

DIFFERENTIATED BY DESIGN:

	400	ORDER MULTIPLE 6
UNIVERSAL WRIST WRAP		
		
<ul style="list-style-type: none"> • Elastic • Ambidextrous • Reversible hook and loop closure 		
ITEM #	SIZE	COLOR
72102	—	Black
72103	—	Tan

	420	ORDER MULTIPLE 6
WRIST WRAP W/ THUMB LOOP		
		
<ul style="list-style-type: none"> • Elastic • Thumb loop • Hook and loop closure • Ambidextrous 		
ITEM #	SIZE	COLOR
72222	S/M	Black
72224	L/XL	Black
72232	S/M	Tan
72234	L/XL	Tan



PERFORATED NEOPRENE

Knee and elbow sleeves made of perforated neoprene for enhanced breathability.

SPANDEX MESH

Spandex mesh for increased comfort and less irritability behind the knee or in the elbow crease.

PRE-CURVE DESIGN

Pre-curved design for improved shape and fit.

600

ORDER
MULTIPLE
1

SINGLE-LAYER NEOPRENE KNEE SLEEVE

- Perforated neoprene
- Binding and pre-curve design
- Spandex mesh behind the knee

ITEM #	SIZE	COLOR	ITEM #	SIZE	COLOR
16502	S	Black	16505	XL	Black
16503	M	Black	16506	2XL	Black
16504	L	Black			

615

ORDER
MULTIPLE
1

KNEE SLEEVE W/ OPEN PATELLA/ANTERIOR PAD

- Perforated neoprene
- Binding and pre-curve design
- Spandex mesh behind the knee
- Double neoprene anterior pad
- Open patella

ITEM #	SIZE	COLOR	ITEM #	SIZE	COLOR
16532	S	Black	16535	XL	Black
16533	M	Black	16536	2XL	Black
16534	L	Black			

620

ORDER
MULTIPLE
1

KNEE SLEEVE W/ OPEN PATELLA/SPIRAL STAYS

- Perforated neoprene
- Binding and pre-curve design
- Thinner perforated neoprene panel behind the knee
- Spiral stays
- Foam buttress support around open patella

ITEM #	SIZE	COLOR	ITEM #	SIZE	COLOR
16542	S	Black	16545	XL	Black
16543	M	Black	16546	2XL	Black
16544	L	Black			

500

ORDER
MULTIPLE
1

ELBOW SUPPORT WRAP

- Nylon laminated neoprene
- Strap with hook and loop closure
- Ambidextrous

ITEM #	SIZE	COLOR	ITEM #	SIZE	COLOR
16001	XS	Black	16004	L	Black
16002	S	Black	16005	XL	Black
16003	M	Black			

650

ORDER
MULTIPLE
1

NEOPRENE ELBOW SLEEVE

- Perforated neoprene
- Spandex mesh in elbow crease
- Binding and pre-curve design

ITEM #	SIZE	COLOR	ITEM #	SIZE	COLOR
16572	S	Black	16575	XL	Black
16573	M	Black	16576	2XL	Black
16574	L	Black			

655

ORDER
MULTIPLE
1

NEOPRENE ELBOW SLEEVE W/ STRAP

- Perforated neoprene
- Spandex mesh in elbow crease
- Binding and pre-curve design
- Adjustable hook and loop strap

ITEM #	SIZE	COLOR	ITEM #	SIZE	COLOR
16582	S	Black	16585	XL	Black
16583	M	Black	16586	2XL	Black
16584	L	Black			



GLOWEAR®
HI-VIS APPAREL



**NEVER LET SAFETY
OUT OF YOUR SIGHT.**



GLOWEAR® HI-VIS APPAREL

Whether out on the highways and byways, spelunking below the crust of the earth ferreting out the next great mother lode, or fixing the energy grid during a blackout, you need to make sure you're visible. Highly visible. To avoid drama on the job, outfit yourself in our ANSI-compliant GloWear® line and become a beacon unto others.

HI-VIS APPAREL // CLASS 2 VEST SERIES



8250Z Surveyors



8248Z Two-Tone Surveyors



8254HDZ Heavy-Duty Surveyors



8230Z Two-Tone

HI-VIS APPAREL // CLASS 3 SERIES



8310HL Economy Mesh



8320Z Standard Mesh



8330Z Standard Two-Tone



8356FRHL FR Modacrylic

HI-VIS APPAREL // CLASS 1 & NON-CERT SERIES



8020HL Non-Certified



8140BA Class 1 Breakaway Sash



8040HL Hi-Gloss Reflective



8080BAX Breakaway Hi-Gloss

HI-VIS APPAREL // FOUL WEATHER SERIES



8365BK Class 3 Rain Jacket



8365 Class 3 Rain Jacket



8385 Class 3 4-In-1 Jacket



8379 Class 3 Bomber Jacket

HI-VIS APPAREL // HEADWEAR SERIES



8940 LED PowerCap™



8935 Ranger Hat



8930 Baseball Cap



8006 Neck Shade



8225HL Standard Solid



8220Z Standard Mesh



8215BA Breakaway Mesh



8210HL Economy Mesh



8260FRHL Flame Resistant

HI-VIS APPAREL
// CLASS E SERIES



8910 Standard Mesh



8910BK Black Bottom Mesh



8911 Two-Tone Mesh

HI-VIS APPAREL
// SHIRT SERIES



8289BK Class 2 T-Shirt



8291BK Class 2 L/S T-Shirt



8295 Polo



8392 Full-Zip Hoodie



8380 Class 3 Bomber Jacket



8915 Class E Rain Pants



8915BK Class E Rain Pants



8918BK Class E Rain Bibs



8925 Class E Thermal Pants

HI-VIS APPAREL
// ACCESSORIES



8001 Arm Band



8003 Hi-Gloss Arm Band



8004 Hi-Vis Seat Belt Cover



8008 Leg Gaiters

GLOWEAR® HI-VIS APPAREL:

CLASS 2 SERIES

DIFFERENTIATED BY DESIGN:



MIC TABS

Durable webbing on shoulders to hold radio mic.

ANSI-COMPLIANT MATERIALS

GloWear® Hi-Vis Apparel is made of ANSI-compliant reflective and background materials to ensure the highest performance.

POCKET OPTIONS

Multiple pocket configurations on vest including large outside pockets to fit a tablet, and large cellphone, multidivisional pocket, and zippered back document/tablet pocket.

3M™ SCOTCHLITE™ REFLECTIVE MATERIAL

3M™ Scotchlite™ glass bead reflective tape meets the ANSI 107 standard and improves visibility of the worker.

CLOSURE OPTIONS

Choose between a variety of hook and loop or zippered vest options.

8250Z



FIND OUT MORE ABOUT THE TECHNOLOGY THAT GOES INTO THE FULL LINE OF ERGODYNE HI-VIS APPAREL AT: WWW.ERGODYNE.COM

	8205 _{HL/Z}	ORDER MULTIPLE 12
--	-----------------------------	-----------------------------

CLASS 2 SUPER ECONO



- ANSI-compliant polyester mesh (3.3oz)
- 2" ANSI-compliant reflective

8205HL: HOOK AND LOOP	8205Z: ZIPPER
------------------------------	----------------------

ITEM #	SIZE	COLOR	ITEM #	SIZE	COLOR
20963	S/M	HV Orange	20983	S/M	HV Orange
20965	L/XL	HV Orange	20985	L/XL	HV Orange
20967	2XL/3XL	HV Orange	20987	2XL/3XL	HV Orange
20969	4XL/5XL	HV Orange	20989	4XL/5XL	HV Orange
20973	S/M	HV Lime	20993	S/M	HV Lime
20975	L/XL	HV Lime	20995	L/XL	HV Lime
20977	2XL/3XL	HV Lime	20997	2XL/3XL	HV Lime
20979	4XL/5XL	HV Lime	20999	4XL/5XL	HV Lime

	8210 _{HL/Z}	ORDER MULTIPLE 12
--	-----------------------------	-----------------------------

CLASS 2 ECONO





- ANSI-compliant polyester mesh (3.3oz)
- 2" ANSI-compliant reflective

8210HL: HOOK AND LOOP	8210Z: ZIPPER
------------------------------	----------------------

ITEM #	SIZE	COLOR	ITEM #	SIZE	COLOR
21013	S/M	HV Orange	21043	S/M	HV Orange
21015	L/XL	HV Orange	21045	L/XL	HV Orange
21017	2XL/3XL	HV Orange	21047	2XL/3XL	HV Orange
21019	4XL/5XL	HV Orange	21049	4XL/5XL	HV Orange
21023	S/M	HV Lime	21053	S/M	HV Lime
21025	L/XL	HV Lime	21055	L/XL	HV Lime
21027	2XL/3XL	HV Lime	21057	2XL/3XL	HV Lime
21029	4XL/5XL	HV Lime	21059	4XL/5XL	HV Lime

	8215 _{BA}	ORDER MULTIPLE 12
--	---------------------------	-----------------------------

CLASS 2 ECONO BREAKAWAY





- ANSI-compliant polyester mesh (3.3oz)
- Hook and loop front closure
- Five-point hook and loop breakaway
- 2" ANSI-compliant reflective
- Pockets: One inside

ITEM #	SIZE	COLOR	ITEM #	SIZE	COLOR
21063	S/M	HV Orange	21073	S/M	Hi-Vis Lime
21065	L/XL	HV Orange	21075	L/XL	Hi-Vis Lime
21067	2XL/3XL	HV Orange	21077	2XL/3XL	Hi-Vis Lime
21069	4XL/5XL	HV Orange	21079	4XL/5XL	Hi-Vis Lime

	8220 _{HL/Z}	ORDER MULTIPLE 12
--	-----------------------------	-----------------------------

CLASS 2 STANDARD - MESH





- ANSI-compliant polyester mesh (3.3oz)
- 2" ANSI-compliant reflective

8220HL: HOOK AND LOOP	8220Z: ZIPPER
------------------------------	----------------------

ITEM #	SIZE	COLOR	ITEM #	SIZE	COLOR
21133	S/M	HV Orange	21113	S/M	HV Orange
21135	L/XL	HV Orange	21115	L/XL	HV Orange
21137	2XL/3XL	HV Orange	21117	2XL/3XL	HV Orange
21139	4XL/5XL	HV Orange	21119	4XL/5XL	HV Orange
21143	S/M	HV Lime	21123	S/M	HV Lime
21245	L/XL	HV Lime	21125	L/XL	HV Lime
21247	2XL/3XL	HV Lime	21127	2XL/3XL	HV Lime
21149	4XL/5XL	HV Lime	21129	4XL/5XL	HV Lime

	8225 _{HL/Z}	ORDER MULTIPLE 12
--	-----------------------------	-----------------------------

CLASS 2 STANDARD - SOLID







- ANSI-compliant polyester solid (3.6oz)
- 2" ANSI-compliant reflective

8225HL: HOOK AND LOOP	8225Z: ZIPPER
------------------------------	----------------------

ITEM #	SIZE	COLOR	ITEM #	SIZE	COLOR
21173	S/M	HV Orange	21153	S/M	HV Orange
21175	L/XL	HV Orange	21155	L/XL	HV Orange
21177	2XL/3XL	HV Orange	21157	2XL/3XL	HV Orange
21179	4XL/5XL	HV Orange	21159	4XL/5XL	HV Orange
21183	S/M	HV Lime	21163	S/M	HV Lime
21185	L/XL	HV Lime	21165	L/XL	HV Lime
21187	2XL/3XL	HV Lime	21167	2XL/3XL	HV Lime
21189	4XL/5XL	HV Lime	21169	4XL/5XL	HV Lime

	8229 _Z	ORDER MULTIPLE 12
--	--------------------------	-----------------------------

CLASS 2 ECONOMY TWO-TONE

- ANSI-compliant polyester mesh (3.3oz)
- 2" ANSI-compliant reflective
- Reflective set on 4.5" contrasting background
- Zipper closure
- One pocket; single mic tab

8229Z: ZIPPER

ITEM #	SIZE	COLOR	ITEM #	SIZE	COLOR
21303	S/M	HV Orange	21293	S/M	HV Lime
21305	L/XL	HV Orange	21295	L/XL	HV Lime
21307	2XL/3XL	HV Orange	21297	2XL/3XL	HV Lime
21309	4XL/5XL	HV Orange	21299	4XL/5XL	HV Lime



8230_Z

ORDER MULTIPLE
12

CLASS 2 TWO-TONE

UPDATED FOR
'16



POCKETS
1 0
INNER OUTER

- ANSI-compliant polyester mesh (3.3oz)
- 2" ANSI-compliant 3M™ Scotchlite™ Reflective
- Reflective set on 4.5" contrasting background
- Zipper closure
- One pocket; single mic tab

8230Z: ZIPPER

ITEM #	SIZE	COLOR	ITEM #	SIZE	COLOR
21313	S/M	HV Orange	21323	S/M	HV Lime
21315	L/XL	HV Orange	21325	L/XL	HV Lime
21317	2XL/3XL	HV Orange	21327	2XL/3XL	HV Lime
21319	4XL/5XL	HV Orange	21329	4XL/5XL	HV Lime



8235_{ZX}

ORDER MULTIPLE
12

CLASS 2 ECONO BREAKAWAY

UPDATED FOR
'16



POCKETS
1 4
INNER OUTER

- ANSI-compliant polyester solid (3.6oz)
- 2" ANSI-compliant 3M™ Scotchlite™ Reflective
- Reflective set on 4.5" contrasting background
- Zipper closure
- Five pockets; D-ring access slot

ITEM #	SIZE	COLOR
26183	S/M	HV Orange
26185	L/XL	HV Orange
26187	2XL/3XL	HV Orange
26189	4XL/5XL	HV Orange



8248_Z

ORDER MULTIPLE
12

CLASS 2 TWO-TONE SURVEYORS

UPDATED FOR
'16



POCKETS
2 4
INNER OUTER

- ANSI-compliant polyester solid front / mesh back
- 2" ANSI-compliant reflective
- Reflective set on 4.5" contrasting background
- Zipper closure
- Six pockets; dual mic tabs

ITEM #	SIZE	COLOR	ITEM #	SIZE	COLOR
24063	S/M	HV Orange	24073	S/M	HV Lime
24065	L/XL	HV Orange	24075	L/XL	HV Lime
24067	2XL/3XL	HV Orange	24077	2XL/3XL	HV Lime
24069	4XL/5XL	HV Orange	24079	4XL/5XL	HV Lime



8249_Z

ORDER MULTIPLE
12

CLASS 2 ECONOMY SURVEYORS

UPDATED FOR
'16



POCKETS
2 2
INNER OUTER

- ANSI-compliant polyester solid front / mesh back
- 2" ANSI-compliant reflective
- Zipper closure
- Four pockets; single mic tab

ITEM #	SIZE	COLOR	ITEM #	SIZE	COLOR
24013	S/M	HV Orange	24023	S/M	HV Lime
24015	L/XL	HV Orange	24025	L/XL	HV Lime
24017	2XL/3XL	HV Orange	24027	2XL/3XL	HV Lime
24019	4XL/5XL	HV Orange	24029	4XL/5XL	HV Lime



8250_Z

ORDER MULTIPLE
12

CLASS 2 SURVEYORS

UPDATED FOR
'16



POCKETS
2 4
INNER OUTER
• REAR POCKET

- ANSI-compliant polyester solid front / mesh back
- 2" ANSI-compliant 3M™ Scotchlite™ Reflective
- Zipper closure
- Six pockets; dual mic tabs
- One large zippered rear document / tablet pocket

ITEM #	SIZE	COLOR	ITEM #	SIZE	COLOR
21413	S/M	HV Orange	21423	S/M	HV Lime
21415	L/XL	HV Orange	21425	L/XL	HV Lime
21417	2XL/3XL	HV Orange	21427	2XL/3XL	HV Lime
21419	4XL/5XL	HV Orange	21429	4XL/5XL	HV Lime



8250_{ZHG}

ORDER MULTIPLE
12

CLASS 2 HI-GLOSS SURVEYORS

UPDATED FOR
'16



POCKETS
2 4
INNER OUTER
• REAR POCKET

- ANSI-compliant polyester solid front / mesh back
- 2" ANSI-compliant 3M™ Scotchlite™ Reflective
- Zipper closure
- Six pockets; dual mic tabs
- One large zippered rear document / tablet pocket

ITEM #	SIZE	COLOR
21433	S/M	HV Orange
21435	L/XL	HV Orange
21437	2XL/3XL	HV Orange
21439	4XL/5XL	HV Orange

8254_{HDZ}

ORDER MULTIPLE
12

CLASS 2 HEAVY DUTY SURVEYORS

UPDATED FOR
'16

POCKETS
2 4
SIDE OUTER
+ REAR POCKET

- ANSI-compliant polyester solid front / mesh back
- 2" ANSI-compliant 3M™ Scotchlite™ Reflective
- Reflective set on 3.5" contrasting background
- Heavy-duty #10 zipper closure
- Six pockets; dual mic tabs

ITEM #	SIZE	COLOR
21453	S/M	HV Orange
21455	L/XL	HV Orange
21457	2XL/3XL	HV Orange
21459	4XL/5XL	HV Orange

8255_{HL}

ORDER MULTIPLE
12

CLASS 2 TREATED POLY

POCKETS
1 0
INNER OUTER

- ANSI-compliant treated polyester solid
- After-flame treatment good for up to 25 washings
- 2" ANSI-compliant 3M™ Scotchlite™ FR Reflective
- Hook and loop closure
- One pocket

ITEM #	SIZE	COLOR
21473	S/M	HV Lime
21475	L/XL	HV Lime
21477	2XL/3XL	HV Lime
21479	4XL/5XL	HV Lime

8260_{FRHL}

ORDER MULTIPLE
12

CLASS 2 FR MODACRYLIC

FR

ATPV 4.6 cal/cm²

NFPA 70E CAT 1

UPDATED FOR
'16

POCKETS
2 0
INNER OUTER

Flame resistant
ASTM F1506

- ANSI-compliant modacrylic mesh (5.6oz)
- ASTM F1506; ATPV of 4.6 cal/cm²
- 2" ANSI-compliant 3M™ Scotchlite™ FR Reflective
- FR hook and loop closure
- Two pockets; D-ring access slot; single mic tab

ITEM #	SIZE	COLOR	ITEM #	SIZE	COLOR
21493	S/M	HV Lime	21497	2XL/3XL	HV Lime
21495	L/XL	HV Lime	21499	4XL/5XL	HV Lime

8240_{HL/IC}

ORDER MULTIPLE
12

CLASS 2 TWO-TONE EXPANDABLE

POCKETS
1 0
INNER OUTER

- ANSI-compliant polyester mesh (3.3oz)
- 2" ANSI-compliant 3M™ Scotchlite™ Reflective
- Reflective set on 4.5" contrasting background
- Hook and loop closure
- One pocket; dual mic tabs

ITEM #	SIZE	COLOR	ITEM #	SIZE	COLOR
21380	M/L	White	21390	M/L	Navy
21382	XL/2XL	White	21392	XL/2XL	Navy
21384	M/L	HV Orange	21394	M/L	HV Lime
21386	XL/2XL	HV Orange	21396	XL/2XL	HV Lime

8244_{PSV}

ORDER MULTIPLE
12

CLASS 2 PUBLIC SAFETY - EXPANDABLE

POCKETS
1 1
INNER OUTER

- ANSI-compliant polyester mesh (3.3oz)
- ANSI-compliant 3M™ Scotchlite™ Reflective
- Adjustable sides
- Hook and loop breakaway on shoulders and sides
- Two pockets; dual mic tabs

ITEM #	SIZE	COLOR	ITEM #	SIZE	COLOR
21360	M/L	HV Orange	21364	M/L	HV Lime
21362	XL/2XL	HV Orange	21366	XL/2XL	HV Lime
21363	3XL+	HV Orange	21367	3XL+	HV Lime

8245_{PSV}

ORDER MULTIPLE
12

CLASS 2 PUBLIC SAFETY

POCKETS
1 0
INNER OUTER

- ANSI-compliant polyester solid front / mesh back
- 2" ANSI-compliant 3M™ Scotchlite™ Reflective
- Reflective set on 3.5" contrasting background
- Heavy-duty #10 zipper closure
- Six pockets; dual mic tabs

ITEM #	SIZE	COLOR	ITEM #	SIZE	COLOR
23383	S/M	HV Orange	23393	S/M	Hi-Vis Lime
23385	L/XL	HV Orange	23395	L/XL	Hi-Vis Lime
23387	2XL/3XL	HV Orange	23397	2XL/3XL	Hi-Vis Lime
23389	4XL/5XL	HV Orange	23399	4XL/5XL	Hi-Vis Lime
23390	6XL/7XL	HV Orange	24000	6XL/7XL	Hi-Vis Lime

GLOWEAR® HI-VIS APPAREL:

CLASS 3 SERIES

DIFFERENTIATED BY DESIGN:



		8310_{HL}	ORDER MULTIPLE 1		
CLASS 3 ECONOMY					
<ul style="list-style-type: none"> • ANSI-compliant polyester mesh (3.3oz) • 2" ANSI-compliant reflective • Hook and loop closure • One pocket 					
ITEM #	SIZE	COLOR	ITEM #	SIZE	COLOR
22013	S/M	HV Orange	22023	S/M	Hi-Vis Lime
22015	L/XL	HV Orange	22025	L/XL	Hi-Vis Lime
22017	2XL/3XL	HV Orange	22027	2XL/3XL	Hi-Vis Lime
22019	4XL/5XL	HV Orange	22029	4XL/5XL	Hi-Vis Lime

ANSI-COMPLIANT MATERIALS

GloWear® Hi-Vis Apparel is made of ANSI-compliant reflective and background materials to ensure the highest performance.

GLASS BEAD REFLECTIVE MATERIAL

Glass bead reflective tape meets the ANSI 107 standard and improves visibility of the worker.

GARMENT DESIGN OPTIONS

Choose between zipper and hook and loop closures, mesh and solid fabrics, two-tone or not...you've got options!

ANSI'S GENERAL THEORY OF CONSPICUITY

MUCH KNOWLEDGE IS CONTAINED IN A SIMPLE EQUATION: 2 + E = 3!

You can obtain Class 3 compliance in one of two ways. The most obvious is to buy an ANSI 107 Class 3 compliant garment. The less obvious—but more popular route—is to wear a Class 2 garment (usually a vest) and pair it with Class E compliant bottoms. Either way, you are clearly high class.



8320_Z

ORDER
MULTIPLE
1

CLASS 3 STANDARD

UPDATED FOR
'16

POCKETS
1 2
INNER OUTER

- ANSI-compliant polyester mesh (3.3oz)
- 2" ANSI-compliant reflective
- Zipper closure
- Three pockets; single mic tab

ITEM #	SIZE	COLOR	ITEM #	SIZE	COLOR
22113	S/M	HV Orange	22123	S/M	HV Lime
22115	L/XL	HV Orange	22125	L/XL	HV Lime
22117	2XL/3XL	HV Orange	22127	2XL/3XL	HV Lime
22119	4XL/5XL	HV Orange	22129	4XL/5XL	HV Lime

8330_Z

ORDER
MULTIPLE
1

CLASS 3 TWO-TONE

UPDATED FOR
'16

POCKETS
1 0
INNER OUTER

- ANSI-compliant polyester mesh (3.3oz)
- 2" ANSI-compliant reflective
- Reflective set on 4.5" contrasting background
- Zipper closure
- One pocket; single mic tab

ITEM #	SIZE	COLOR	ITEM #	SIZE	COLOR
22173	S/M	HV Orange	22183	S/M	HV Lime
22175	L/XL	HV Orange	22185	L/XL	HV Lime
22177	2XL/3XL	HV Orange	22187	2XL/3XL	HV Lime
22179	4XL/5XL	HV Orange	22189	4XL/5XL	HV Lime

8356_{FRHL}

ORDER
MULTIPLE
1

CLASS 3 FR MODACRYLIC

NFPA 70E CAT 1
ATPV 4.6 CAL/CM²

UPDATED FOR
'16

POCKETS
2 0
INNER OUTER

Flame resistant
ASTM F1506

- ANSI-compliant modacrylic mesh (5.6oz)
- ASTM F1506; ATPV of 4.6 cal/cm²
- 2" ANSI-compliant 3M™ Scotchlite™ FR Reflective
- FR hook and loop closure
- Two pockets; D-ring access slot

ITEM #	SIZE	COLOR	ITEM #	SIZE	COLOR
22213	S/M	HV Lime	22217	2XL/3XL	HV Lime
22215	L/XL	HV Lime	22219	4XL/5XL	HV Lime

8910

ORDER
MULTIPLE
1

CLASS E HI-VIS PANTS

UPDATED FOR
'16

- ANSI-compliant polyester mesh (3.3oz)
- 2" ANSI-compliant reflective
- Drawstring waist, right leg cargo pocket
- Wide leg openings with hook and loop closures

ITEM #	SIZE	COLOR	ITEM #	SIZE	COLOR
22853	S/M	HV Orange	22953	S/M	HV Lime
22855	L/XL	HV Orange	22955	L/XL	HV Lime
22857	2XL/3XL	HV Orange	22957	2XL/3XL	HV Lime
22859	4XL/5XL	HV Orange	22959	4XL/5XL	HV Lime

8910_{BK}

ORDER
MULTIPLE
1

CLASS E HI-VIS MESH PANTS WITH BLACK BOTTOM

NEW FOR
'16

- ANSI-compliant polyester mesh (3.3oz)
- 2" ANSI-compliant reflective
- Drawstring waist; right leg cargo pocket
- Wide leg openings with hook and loop closures
- Black accents on bottom of leg high wear areas

ITEM #	SIZE	COLOR	ITEM #	SIZE	COLOR
23953	S/M	HV Lime	23955	L/XL	HV Lime
23957	2XL/3XL	HV Lime	23959	4XL/5XL	HV Lime

8911

ORDER
MULTIPLE
1

CLASS E TWO-TONE PANTS

UPDATED FOR
'16

- ANSI-compliant polyester mesh (3.3oz)
- 2" ANSI-compliant reflective
- Reflective set on 4.5" contrasting background
- Drawstring waist; right leg cargo pocket
- Wide leg openings with hook and loop closures

ITEM #	SIZE	COLOR	ITEM #	SIZE	COLOR
22863	S/M	HV Orange	22963	S/M	HV Lime
22865	L/XL	HV Orange	22965	L/XL	HV Lime
22867	2XL/3XL	HV Orange	22967	2XL/3XL	HV Lime
22869	4XL/5XL	HV Orange	22969	4XL/5XL	HV Lime

GLOWEAR® HI-VIS APPAREL:

NON-CERTIFIED & CLASS 1 SERIES

DIFFERENTIATED BY DESIGN:

BREAKAWAY DESIGN

Non-Certified and Class 1 breakaway design options.

HI-VIS MATERIALS

GloWear® Non-Certified vests use lightweight, breathable hi-vis materials.

GLASS BEAD OR HI-GLOSS REFLECTIVE MATERIAL

Glass bead reflective material improves worker visibility; hi-gloss reflective material provides visibility both day and night and is very effective in wet conditions.



8080BAX



FIND OUT MORE ABOUT THE TECHNOLOGY THAT GOES INTO THE FULL LINE OF ERGODYNE HI-VIS APPAREL AT: WWW.ERGODYNE.COM

	8010_{HL}	ORDER MULTIPLE 1
--	--------------------------	----------------------------

NON-CERTIFIED ECONOMY

- Polyester mesh (2.6oz)
- Hook and loop closure

ITEM #	SIZE	COLOR
20010	—	HV Orange
20020	—	HV Lime

	8020_{HL}	ORDER MULTIPLE 1
--	--------------------------	----------------------------

NON-CERTIFIED STANDARD

- Polyester mesh (2.6oz)
- 1" reflective
- Hook and loop closure

ITEM #	SIZE	COLOR
20030	—	HV Orange
20040	—	HV Lime

	8040_{HL}	ORDER MULTIPLE 1
--	--------------------------	----------------------------

NON-CERTIFIED HI-GLOSS

- Polyester mesh (2.6oz)
- 1" hi-gloss reflective
- Hook and loop closure

ITEM #	SIZE	COLOR
20070	—	HV Orange
20080	—	HV Lime

		8080_{BAX}	ORDER MULTIPLE 1
--	--	---------------------------	----------------------------

NON-CERTIFIED X-BACK

- Polyester mesh (2.6oz)
- 2" hi-gloss reflective
- Hook and loop closure
- Breakaway shoulders

ITEM #	SIZE	COLOR
26030	—	HV Orange
26040	—	HV Lime

		8140_{BA}	ORDER MULTIPLE 1
--	--	--------------------------	----------------------------

CLASS 1 BREAKAWAY SASH

- ANSI-compliant oxford polyester
- 1.375" ANSI-compliant 3M™ Scotchlite™ Reflective
- X-back design
- Breakaway shoulders and sides
- One pocket

ITEM #	SIZE	COLOR
27017	M/L	HV Orange
27018	XL/2XL	HV Orange
27019	3XL*	HV Orange
27014	M/L	HV Lime
27015	XL/2XL	HV Lime
27016	3XL*	HV Lime

GLOWEAR® HI-VIS APPAREL:

SHIRT SERIES

DIFFERENTIATED BY DESIGN:

MOISTURE WICKING TREATMENT

Wicking fabrics move moisture away, dry fast, and keep you comfortable in all temperatures.

COMPLIANT MATERIALS

GloWear® Hi-Vis Apparel is made of ANSI-compliant reflective and background materials to assure the highest performance.



8291BK

HEAT TRANSFER REFLECTIVE MATERIAL

Every square inch meets the ANSI 107 standard, flexible heat transfer material for maximum comfort.

GARMENT DESIGN OPTIONS

With polyester breathable knits and polyester polar fleece, polos, T-shirts or sweatshirts, you've got options!



FIND OUT MORE ABOUT THE TECHNOLOGY THAT GOES INTO THE FULL LINE OF ERGODYNE HI-VIS APPAREL AT: WWW.ERGODYNE.COM



8289_{BK}

ORDER MULTIPLE 1

CLASS 2 T-SHIRT (BLACK FRONT)



- ANSI-compliant polyester breathable knit (4.1oz)
- 2" ANSI-compliant heat transfer reflective
- Moisture wicking treatment

ITEM #	SIZE	COLOR	ITEM #	SIZE	COLOR
22502	S	HV Lime	22512	S	HV Orange
22503	M	HV Lime	22513	M	HV Orange
22504	L	HV Lime	22514	L	HV Orange
22505	XL	HV Lime	22515	XL	HV Orange
22506	2XL	HV Lime	22516	2XL	HV Orange
22507	3XL	HV Lime	22517	3XL	HV Orange
22508	4XL	HV Lime	22518	4XL	HV Orange
22509	5XL	HV Lime	22519	5XL	HV Orange



8291_{BK}

ORDER MULTIPLE 1

CLASS 2 LONG SLEEVE T-SHIRT (BLACK FRONT)



- ANSI-compliant polyester breathable knit (4.1oz)
- 2" ANSI-compliant heat transfer reflective
- Moisture wicking treatment

ITEM #	SIZE	COLOR	ITEM #	SIZE	COLOR
22702	S	HV Lime	22712	S	HV Orange
22703	M	HV Lime	22713	M	HV Orange
22704	L	HV Lime	22714	L	HV Orange
22705	XL	HV Lime	22715	XL	HV Orange
22706	2XL	HV Lime	22716	2XL	HV Orange
22707	3XL	HV Lime	22717	3XL	HV Orange
22708	4XL	HV Lime	22718	4XL	HV Orange
22709	5XL	HV Lime	22719	5XL	HV Orange

8089

ORDER MULTIPLE
1

NON-CERTIFIED T-SHIRT

POCKETS
0 1
INNER OUTER

- Polyester breathable knit (4.1oz)
- Moisture wicking treatment

ITEM #	SIZE	COLOR	ITEM #	SIZE	COLOR
21552	S	HV Lime	21562	S	HV Orange
21553	M	HV Lime	21563	M	HV Orange
21554	L	HV Lime	21564	L	HV Orange
21555	XL	HV Lime	21565	XL	HV Orange
21556	2XL	HV Lime	21566	2XL	HV Orange
21557	3XL	HV Lime	21567	3XL	HV Orange
21558	4XL	HV Lime	21568	4XL	HV Orange
21559	5XL	HV Lime	21569	5XL	HV Orange

8091

ORDER MULTIPLE
1

NON-CERTIFIED LONG SLEEVE T-SHIRT

POCKETS
0 1
INNER OUTER

- Polyester breathable knit (4.1oz)
- Moisture wicking treatment

ITEM #	SIZE	COLOR	ITEM #	SIZE	COLOR
21582	S	HV Lime	21592	S	HV Orange
21583	M	HV Lime	21593	M	HV Orange
21584	L	HV Lime	21594	L	HV Orange
21585	XL	HV Lime	21595	XL	HV Orange
21586	2XL	HV Lime	21596	2XL	HV Orange
21587	3XL	HV Lime	21597	3XL	HV Orange
21588	4XL	HV Lime	21598	4XL	HV Orange
21589	5XL	HV Lime	21599	5XL	HV Orange

8289

ORDER MULTIPLE
1

CLASS 2 T-SHIRT

POCKETS
0 1
INNER OUTER

- ANSI-compliant polyester breathable knit (4.1oz)
- 2" ANSI-compliant heat transfer reflective
- Moisture wicking treatment

ITEM #	SIZE	COLOR	ITEM #	SIZE	COLOR
21502	S	HV Lime	21512	S	HV Orange
21503	M	HV Lime	21513	M	HV Orange
21504	L	HV Lime	21514	L	HV Orange
21505	XL	HV Lime	21515	XL	HV Orange
21506	2XL	HV Lime	21516	2XL	HV Orange
21507	3XL	HV Lime	21517	3XL	HV Orange
21508	4XL	HV Lime	21518	4XL	HV Orange
21509	5XL	HV Lime	21519	5XL	HV Orange

8295

ORDER MULTIPLE
1

CLASS 2 POLO SHIRT

POCKETS
0 1
INNER OUTER

- ANSI-compliant polyester breathable knit (4.1oz)
- 2" ANSI-compliant heat transfer reflective
- Moisture wicking treatment
- Split tail hem
- One outside chest pocket

ITEM #	SIZE	COLOR	ITEM #	SIZE	COLOR
21642	S	HV Lime	21646	2XL	HV Lime
21643	M	HV Lime	21647	3XL	HV Lime
21644	L	HV Lime	21648	4XL	HV Lime
21645	XL	HV Lime	21649	5XL	HV Lime

8391

ORDER MULTIPLE
1

CLASS 3 LONG SLEEVE T-SHIRT

POCKETS
0 1
INNER OUTER

- ANSI-compliant polyester breathable knit (4.1oz)
- 2" ANSI-compliant heat transfer reflective
- Moisture wicking treatment

ITEM #	SIZE	COLOR	ITEM #	SIZE	COLOR
21702	S	HV Lime	21712	S	HV Orange
21703	M	HV Lime	21713	M	HV Orange
21704	L	HV Lime	21714	L	HV Orange
21705	XL	HV Lime	21715	XL	HV Orange
21706	2XL	HV Lime	21716	2XL	HV Orange
21707	3XL	HV Lime	21717	3X	HV Orange
21708	4XL	HV Lime	21718	4XL	HV Orange
21709	5XL	HV Lime	21719	5X	HV Orange

MAKE IT CUSTOM!

HERE'S THE DRILL: CUSTOM LOGO PROGRAM



Because we have so many options and styles of products available to custom logo, we can do almost anything.

YOU GIVE US:

- Suitable digital art files or camera-ready artwork. (EPS-format files work best but large, hi-res TIF or JPG files [300+ dpi] work too.)
- All necessary PMS/Pantone colors.
- Approval of a digital mock-up.

WE GIVE YOU: A product with a look all your own.

Minimums vary based on the type of product. Don't worry, it's low.

Call Ergodyne Customer Support today to answer all of your custom logo questions... We'll make it easy for you to look good!

	8293	ORDER MULTIPLE 1
--	-------------	----------------------------

CLASS 2 HOODED SWEATSHIRT (BLACK FRONT)

POCKETS 01
INNER OUTER

- ANSI-compliant polyester polar fleece (8oz)
- 2" ANSI-compliant heat transfer reflective
- Black accents on front and sleeve: high-wear areas
- Drawstring hood
- Front pouch-style pocket

ITEM #	SIZE	COLOR	ITEM #	SIZE	COLOR
21682	S	HV Lime	21686	2XL	HV Lime
21683	M	HV Lime	21687	3XL	HV Lime
21684	L	HV Lime	21688	4XL	HV Lime
21685	XL	HV Lime	21689	5XL	HV Lime

	8393	ORDER MULTIPLE 1
--	-------------	----------------------------

CLASS 3 HOODED SWEATSHIRT

POCKETS 01
INNER OUTER

- ANSI-compliant polyester polar fleece (8oz)
- 2" ANSI-compliant heat transfer reflective

ITEM #	SIZE	COLOR	ITEM #	SIZE	COLOR
21762	S	HV Lime	21772	S	HV Orange
21763	M	HV Lime	21773	M	HV Orange
21764	L	HV Lime	21774	L	HV Orange
21765	XL	HV Lime	21775	XL	HV Orange
21766	2XL	HV Lime	21776	2XL	HV Orange
21767	3XL	HV Lime	21777	3XL	HV Orange
21768	4XL	HV Lime	21778	4XL	HV Orange
21769	5XL	HV Lime	21779	5XL	HV Orange

				8396_{FR}	ORDER MULTIPLE 1
--	--	--	--	--------------------------	----------------------------

CLASS 3 FR HOODED SWEATSHIRT

FR **NFPA 70E CAT 2 ATPV 19.7 CAL/CM²**

POCKETS 01
INNER OUTER

NEW FOR '16

- ANSI-compliant cotton modacrylic polar fleece (10oz)
- ASTM F1506; ATPV of 19.7 cal/cm²
- 2" ANSI-compliant 3M™ Scotchlite™ FR Reflective
- Drawstring hood
- Pockets: Front pouch-style

ITEM #	SIZE	COLOR	ITEM #	SIZE	COLOR
TBD	S	HV Lime	TBD	2XL	HV Lime
TBD	M	HV Lime	TBD	3XL	HV Lime
TBD	L	HV Lime	TBD	4XL	HV Lime
TBD	XL	HV Lime	TBD	5XL	HV Lime

	8392	ORDER MULTIPLE 1
--	-------------	----------------------------

CLASS 3 FULL-ZIP HOODED SWEATSHIRT

POCKETS 02
INNER OUTER

- ANSI-compliant polyester polar fleece (8oz)
- 2" ANSI-compliant heat transfer reflective

ITEM #	SIZE	COLOR	ITEM #	SIZE	COLOR
21742	S	HV Lime	21752	S	HV Orange
21743	M	HV Lime	21753	M	HV Orange
21744	L	HV Lime	21754	L	HV Orange
21745	XL	HV Lime	21755	XL	HV Orange
21746	2XL	HV Lime	21756	2XL	HV Orange
21747	3XL	HV Lime	21757	3XL	HV Orange
21748	4XL	HV Lime	21758	4XL	HV Orange
21749	5XL	HV Lime	21759	5XL	HV Orange

	8397	ORDER MULTIPLE 1
--	-------------	----------------------------

CLASS 3 CREW NECK SWEATSHIRT

- ANSI-compliant polyester polar fleece (8oz)
- 2" ANSI-compliant heat transfer reflective
- Crew neck design

ITEM #	SIZE	COLOR	ITEM #	SIZE	COLOR
21672	S	HV Lime	21676	2XL	HV Lime
21673	M	HV Lime	21677	3XL	HV Lime
21674	L	HV Lime	21678	4XL	HV Lime
21675	XL	HV Lime	21679	5XL	HV Lime

	8399	ORDER MULTIPLE 1
--	-------------	----------------------------

CLASS 3 1/2 ZIP SWEATSHIRT

- ANSI-compliant polyester polar fleece (8oz)
- 2" ANSI-compliant heat transfer reflective
- Zipper with "Be Tenacious" zipper pull
- Split tail hem
- Gathered elastic cuffs

ITEM #	SIZE	COLOR	ITEM #	SIZE	COLOR
21782	S	HV Lime	21786	2XL	HV Lime
21783	M	HV Lime	21787	3XL	HV Lime
21784	L	HV Lime	21788	4XL	HV Lime
21785	XL	HV Lime	21789	5XL	HV Lime

GLOWEAR® HI-VIS APPAREL:

FOUL WEATHER SERIES

DIFFERENTIATED BY DESIGN:

COMPLIANT MATERIALS

GloWear® Hi-Vis Apparel is made of ANSI-compliant reflective and background materials to assure the highest performance.

3M™ SCOTCHLITE™ REFLECTIVE

3M™ Scotchlite™ glass bead reflective tape meets the ANSI 107 standard and improves visibility of the worker.

BREATHABLE PU COATING

Breathable PU poly shell keeps water out while letting perspiration escape for warm, dry comfort.

BLACK ACCENTED DESIGN

Black accents on jackets and pants in high wear areas to keep garment appearance clean.



CLASS 3 RAIN JACKET (BLACK FRONT)

ANSI 3M

8365 BK ORDER MULTIPLE 1

- Weatherproof 300D oxford outer shell
- Breathable PU coating, polyester mesh lining
- 2" ANSI-compliant 3M™ Scotchlite™ Reflective
- Black accents on front and sleeve high wear areas
- Three pockets; dual mic tabs

ITEM #	SIZE	COLOR
25322	S	HV Lime
25323	M	HV Lime
25324	L	HV Lime
25325	XL	HV Lime
25326	2XL	HV Lime
25327	3XL	HV Lime
25328	4XL	HV Lime
25329	5XL	HV Lime

CLASS 3 RAIN JACKET

ANSI 3M

8365 ORDER MULTIPLE 1

- Weatherproof 300D oxford outer shell
- Breathable PU coating, polyester mesh lining
- 2" ANSI-compliant 3M™ Scotchlite™ Reflective
- Three pockets; dual mic tabs

ITEM #	SIZE	COLOR	ITEM #	SIZE	COLOR
24312	S	HV Orange	24322	S	HV Lime
24313	M	HV Orange	24323	M	HV Lime
24314	L	HV Orange	24324	L	HV Lime
24315	XL	HV Orange	24325	XL	HV Lime
24316	2XL	HV Orange	24326	2XL	HV Lime
24317	3XL	HV Orange	24327	3XL	HV Lime
24318	4XL	HV Orange	24328	4XL	HV Lime
24319	5XL	HV Orange	24329	5XL	HV Lime

CLASS 3 4-IN-1 JACKET

ANSI 3M

8385 ORDER MULTIPLE 1

- Weatherproof 300D oxford outer shell
- Breathable PU coating
- Inner jacket with 100g 3M™ Thinsulate™ lining
- 2" ANSI-compliant 3M™ Scotchlite™ Reflective
- Removable sleeves
- Five pockets

ITEM #	SIZE	COLOR	ITEM #	SIZE	COLOR
24372	S	HV Orange	24382	S	HV Lime
24373	M	HV Orange	24383	M	HV Lime
24374	L	HV Orange	24384	L	HV Lime
24375	XL	HV Orange	24385	XL	HV Lime
24376	2XL	HV Orange	24386	2XL	HV Lime
24377	3XL	HV Orange	24387	3XL	HV Lime
24378	4XL	HV Orange	24388	4XL	HV Lime
24379	5XL	HV Orange	24389	5XL	HV Lime

8379

ORDER MULTIPLE
10

CLASS 3 ECONOMY BOMBER JACKET

POCKETS
03
INNER OUTER

- Weatherproof 100% polyester outer shell
- Breathable PU coating
- Zip-out 190g microfleece liner
- 2" Level 2 ANSI-compliant reflective material
- Inset hood with drawstring and stoppers

ITEM #	SIZE	COLOR	ITEM #	SIZE	COLOR
24472-CP	S	HV Lime	24476-CP	2XL	HV Lime
24473-CP	M	HV Lime	24477-CP	3XL	HV Lime
24474-CP	L	HV Lime	24478-CP	4XL	HV Lime
24475-CP	XL	HV Lime	24479-CP	5XL	HV Lime

8380

ORDER MULTIPLE
1

CLASS 3 BOMBER JACKET

POCKETS
03
INNER OUTER

- Weatherproof 100% polyester outer shell
- Breathable PU coating
- Inner jacket with fleece lining
- 2" ANSI-compliant 3M™ Scotchlite™ Reflective

ITEM #	SIZE	COLOR	ITEM #	SIZE	COLOR
24482	S	HV Orange	24492	S	HV Lime
24483	M	HV Orange	24493	M	HV Lime
24484	L	HV Orange	24494	L	HV Lime
24485	XL	HV Orange	24495	XL	HV Lime
24486	2XL	HV Orange	24496	2XL	HV Lime
24487	3XL	HV Orange	24497	3XL	HV Lime
24488	4XL	HV Orange	24498	4XL	HV Lime
24489	5XL	HV Orange	24499	5XL	HV Lime

8915

ORDER MULTIPLE
1

CLASS E RAIN PANTS

UPDATED FOR
'16

- Weatherproof 300D oxford outer shell
- Breathable PU coating
- 2" ANSI-compliant 3M™ Scotchlite™ Reflective
- Elastic waistband; right leg cargo pocket
- Zippered leg openings for easy on/off

ITEM #	SIZE	COLOR	ITEM #	SIZE	COLOR
24412	S	HV Orange	24422	S	HV Lime
24413	M	HV Orange	24423	M	HV Lime
24414	L	HV Orange	24424	L	HV Lime
24415	XL	HV Orange	24425	XL	HV Lime
24416	2XL	HV Orange	24426	2XL	HV Lime
24417	3XL	HV Orange	24427	3XL	HV Lime
24418	4XL	HV Orange	24428	4XL	HV Lime
24419	5XL	HV Orange	24429	5XL	HV Lime

8915_{BK}

ORDER MULTIPLE
1

CLASS E RAIN PANTS (BLACK BOTTOM)

NEW FOR
'16

- Weatherproof 300D oxford outer shell
- Breathable PU coating
- 2" ANSI-compliant 3M™ Scotchlite™ Reflective
- Elastic waistband; right leg cargo pocket
- Black accents on bottom of leg high wear areas

ITEM #	SIZE	COLOR	ITEM #	SIZE	COLOR
25422	S	HV Lime	25426	2XL	HV Lime
25423	M	HV Lime	25427	3XL	HV Lime
25424	L	HV Lime	25428	4XL	HV Lime
25425	XL	HV Lime	25429	5XL	HV Lime

8918_{BK}

ORDER MULTIPLE
1

CLASS E RAIN BIBS

NEW FOR
'16

- Weatherproof 300D oxford outer shell
- Breathable PU coating
- 2" ANSI-compliant 3M™ Scotchlite™ Reflective
- Adjustable elastic suspenders; right cargo pocket
- Black accents on bottom of leg high wear areas

ITEM #	SIZE	COLOR	ITEM #	SIZE	COLOR
25012	S	HV Lime	25016	2XL	HV Lime
25013	M	HV Lime	25017	3XL	HV Lime
25014	L	HV Lime	25018	4XL	HV Lime
25015	XL	HV Lime	25019	5XL	HV Lime

8925

ORDER MULTIPLE
1

CLASS E THERMAL PANTS

UPDATED FOR
'16

- Weatherproof 100% polyester outer shell
- Breathable PU coating
- 80g 3M™ Thinsulate™ lining
- 2" ANSI-compliant 3M™ Scotchlite™ Reflective
- Elastic waistband; right leg cargo pocket

ITEM #	SIZE	COLOR	ITEM #	SIZE	COLOR
24442	S	HV Orange	24452	S	HV Lime
24443	M	HV Orange	24453	M	HV Lime
24444	L	HV Orange	24454	L	HV Lime
24445	XL	HV Orange	24455	XL	HV Lime
24446	2XL	HV Orange	24456	2XL	HV Lime
24447	3XL	HV Orange	24457	3XL	HV Lime
24448	4XL	HV Orange	24458	4XL	HV Lime
24449	5XL	HV Orange	24459	5XL	HV Lime

GLOWEAR® HI-VIS APPAREL:

HEADWEAR SERIES

DIFFERENTIATED BY DESIGN:

MESH VENTING

360° ventilated panels allow air to better circulate - cool your melon!

COMPLIANT MATERIALS

GloWear® Hi-Vis Apparel is made of ANSI-compliant reflective and background materials to assure the highest performance.



8935

GLASS BEAD REFLECTIVE MATERIAL

Glass bead reflective tape meets the ANSI 107 standard and improves visibility of the worker.

HEADWEAR DESIGN OPTIONS

Baseball cap or ranger hat, with or without LED lights, lime or orange - you have options!



FIND OUT MORE ABOUT THE TECHNOLOGY THAT GOES INTO THE FULL LINE OF ERGODYNE HI-VIS APPAREL AT: WWW.ERGODYNE.COM

			8940	ORDER MULTIPLE 1	
POWERCAP®					
<ul style="list-style-type: none"> • Two LEDs in brim; two concealed under the brim • LEDs have a bulb life of approximately 100K hours • LEDs emit white light • Four replaceable CR2032 lithium batteries included • ANSI 107 Class Headwear lime or orange 					
8940:			8940RT:		
ITEM #	SIZE	COLOR	ITEM #	SIZE	COLOR
23290	—HV	Lime	23294	—Camo	(Blank)
23291	—HV	Orange	23274	—Camo	(Ergo Logo)
23292	—	Black			
23272	—	Black (Ergo Logo)			

			8935	ORDER MULTIPLE 1	
HI-VIS RANGER HAT					
<ul style="list-style-type: none"> • ANSI-compliant 150D oxford polyester • Mesh venting panels • 1" ANSI-compliant reflective • Three sizes: S/M (21-22.5"), L/XL (22.5-24"), 2XL/3XL (24-25.5") 					
ITEM #	SIZE	COLOR	ITEM #	SIZE	COLOR
23257	S/M	HV Orange	23259	S/M	HV Lime
23258	L/XL	HV Orange	23260	L/XL	HV Lime
23262	2XL/3XL	HV Orange	23261	2XL/3XL	HV Lime

	8930	ORDER MULTIPLE 1
HI-VIS BASEBALL CAP		
		
<ul style="list-style-type: none"> • ANSI-compliant 150D oxford polyester • Mesh venting panels • .25" ANSI-compliant reflective 		
ITEM #	SIZE	COLOR
23238	—	HV Orange
23239	—	HV Lime

	8004	ORDER MULTIPLE 6
HI-VIS SEAT BELT COVER		
		
<ul style="list-style-type: none"> • ANSI-compliant polyester solid fabric (3.6oz) • 2" ANSI-compliant reflective • Hook and loop closures • Fits standard width seat belt harness 		
ITEM #	SIZE	COLOR
29041	—	HV Orange
29043	—	HV Lime

3M	8008	ORDER MULTIPLE 6
HI-VIS LEG GAITERS		
		
<ul style="list-style-type: none"> • Weatherproof polyester shell with PU coating • 2" ANSI-compliant 3M™ Scotchlite™ Reflective • Drawstring closures on top and bottom 		
ITEM #	SIZE	COLOR
29081	—	HV Orange
29083	—	HV Lime

	8006	ORDER MULTIPLE 1
HI-VIS NECK SHADE		
		
<ul style="list-style-type: none"> • ANSI-compliant polyester solid fabric (3.6oz) • Reflective binding • Hook and loop closures • Attaches to hard hat suspension headbands 		
ITEM #	SIZE	COLOR
29061	—	HV Orange
29063	—	HV Lime

3M	8003	ORDER MULTIPLE 12
ARM/LEG BAND - BUCKLE		
		
<ul style="list-style-type: none"> • Woven elastic band • ANSI-compliant 3M™ Scotchlite™ Reflective • Adjusts from 13" to 16" 		
ITEM #	SIZE	COLOR
29031	—	HV Orange
29033	—	HV Lime

3M	8001	ORDER MULTIPLE 12			
ARM/LEG BAND - SNAP					
					
<ul style="list-style-type: none"> • Knit elastic band • ANSI-compliant 3M™ Scotchlite™ Reflective • Two sizes: S/M (12"), L/XL (15") 					
ITEM #	SIZE	COLOR	ITEM #	SIZE	COLOR
29011	S/M	HV Orange	29013	S/M	HV Lime
29012	L/XL	HV Orange	29014	L/XL	HV Lime



MODEL 4Z527E
INPUT VOLTS AC 115
HZ 50 / 60
CONTROL SHIPPED WITH 3 AMP FUSE
CAUTION: USE ONLY PERMANENT MAGNET DC MOTOR TO A SUPPLY SYMMETRIC AMP PROTECTION MUST BE PROVIDED.
MANUFACTURED FOR DAYTON ELECTRIC MFG. CO., NILES, IL 60714 USA

HP 1 / 50 - 1 / 6
ARM VOLTS DC 90
REF. NO. 106297801

FUSING TABLE	
HP	LINE
1/8	6 3 2 1
1/8	1
1/35-1/10	
1/50-1/40	

FUSE TYPE - USE ONLY FAST ACTING GAB 250V OR EQ. DO NOT USE SLOW-BLOW FUSES.

UL LISTED
NO. 5001 ED
UL

SKULLERZ®

EYE PROTECTION

**WORKPLACE REQUIRED.
MILITARY INSPIRED.
ALWAYS DESIRED.**





SKULLERZ® EYE PROTECTION

Say hello to a piping hot, new selection of advanced ANSI-approved eyeball protection. Offering ferocious frame styles for every taste, our new Skullerz® Safety Glasses are Norse-god inspired and forge-fired to withstand even a ballistic impact assault below the brows. With comfort frames, optional Fog-Off™ technology, a host of precision view polycarbonate lenses, and an ultra-lightweight design, these babies don't just throw down the gauntlet on ordinary workplace shades – they come in low out of the rising sun and firebomb the tree line of every workplace eye protection brand that came before them.

EYE PROTECTION // SERIES LEVEL



ODIN Safety Glasses



THOR Safety Glasses



DAGR Safety Glasses



BALDR Safety Glasses



KVASIR Safety Glasses



VALKYRIE Safety Glasses



ERDA Safety Glasses



NJORD Safety Glasses



LOKI Safety Glasses/Goggles

EYE PROTECTION // ACCESSORY SERIES



3200 Cotton Lanyard



3215 Breakaway Cotton Lanyard



3251 Breakaway Rope Lanyard



3275 Neoprene Lanyard



3280 Coil Lanyard



Gasket & Elastic Strap



3216 Microfiber Cleaning Cloth



3218 Microfiber Cleaning Bag



3222 Zipper Case w/ Clip



3225 Ballistic Zipper Case



SKULLERZ
EYE & HEAD
PROTECTION



ANSI & MIL-PRF STANDARDS WORKPLACE REQUIRED, MILITARY INSPIRED.

On the job when the sledding gets tough, there's no time for the specs not to meet the specs. Luckily, Skullerz® Eye Protection goes above and beyond the call of duty to keep vision clear, protected, and ready for action. Full ANSI Z87.1+ High Impact compliance comes standard – but so does MIL-PRF Ballistic Fragmentation Class 1 protection, the US Military's test for spectacle impact protection. Stand and deliver.

MIL-PRF 32432
Impact Steel Projectile



ANSI Z87.1
Impact Steel Ball

IMPACT: HOW FAST IS FAST?

Another day at battle is always unpredictable and might be full of the slings and arrows of outrageous fortune. Whatever the job throws, shoots, or flings, it's essential to be ready for action. Luckily, you chose Skullerz® Eye Protection. From dangerous tools to everyday dust and debris, you can count on Skullerz® Eye Protection for tested, proven protection. We'd still watch out for that rogue barbarian though.

Pneumatic Nail Gun	490 ft. // 149m sec
Nolan Ryan Fastball	148 ft. // 45m sec
Catapult	843 ft. // 257m sec

All Skullerz® models are independently third-party tested at COLTS Laboratories.  COLTS | Laboratories™

SKULLERZ® EYE PROTECTION:

THE ANATOMY OF EYE DEFENSE.

DIFFERENTIATED BY DESIGN:

ANSI Z87.1

ANSI Z87.1 is the US standard for Personal Eye and Face Protection Devices. This standard provides the general performance requirements, testing methods, and required markings for safety spectacles, goggles, faceshields, and welding helmet lenses. All Skullerz® Eye Protection models comply with the spectacle requirements of ANSI Z87.1 and are marked with a "+" to denote compliance with the High Velocity Impact Test. The Loki model also meets ANSI goggle requirements when worn with the optional elastic strap. All Skullerz® models are independently third-party tested at COLTS Laboratories.™

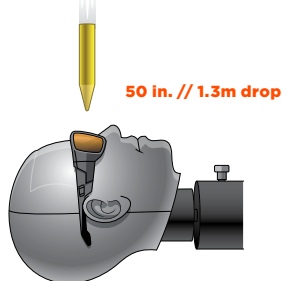
ANSI STANDARDS. TESTED ON DUMMIES, CAUSE YOU AREN'T ONE.
**ANSI Z87.1 Sec. 6.2.2
High Mass Impact Test
Simulates Blunt Force**

- 18 oz. // 500g steel "missile" dropped from 50 in. // 1.3m onto lenses
- Lenses must not puncture, crack or shatter
- All Skullerz® Eye Protection pass this test for spectacles

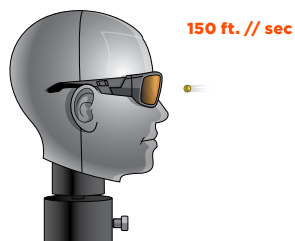
**ANSI Z87.1 Sec. 6.2.3
High Velocity Impact Test
Simulates a Shotgun Blast**

- Steel ball shot @ 150 ft. // 46m per second for glasses; 250 ft. // 76m for goggles
- Lenses must not puncture, crack or shatter; frames must retain the lenses and not break
- All Skullerz® Eye Protection pass this test which is noted with a "+" on the lens; Loki passes for both spectacles and goggles

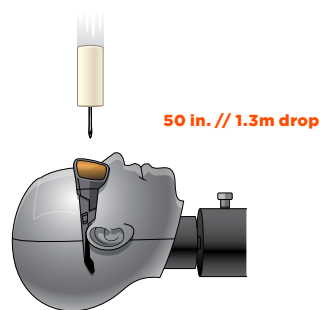
**ANSI Z87.1 Sec. 6.2.4
Penetration Test
Simulates a Poke in the Eye!**

- Weighted needle dropped from 50 in. // 1.3m onto lenses
- Lenses must not puncture, crack or shatter
- All Skullerz® Eye Protection pass this test for spectacles

**MIL-PRF 32432 BALLISTIC
FRAGMENTATION - CLASS 1**

MIL-PRF-32432 is the US Military Combat Eye Protection System (MCEPS) Performance Specification for eyewear. One key performance metric is the Ballistic Fragmentation Protection Test. All Skullerz® Eye Protection meet the rigorous requirements of this test for Class 1 (spectacles).

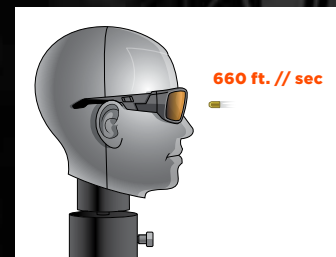
**MIL-PRF 32432 Ballistic
Fragmentation - Class 1
Simulates Shrapnel Fragments**

- Steel projectile shot @ 660 ft. // 201m per second
- Lenses must not puncture, crack or shatter; frames must retain the lenses and not break
- All Skullerz® Eye Protection pass this test for spectacles



**SKULLERZ®
FRAME OPTIONS**

Ergodyne Skullerz® Safety Glasses are available in a variety of frame color options to perfectly suit your jobsite style. See the specific model for frame availability. Choose from:



FRAME: BLACK
AVAILABLE ON:
ODIN, THOR, DAGR, KVASIR, VALKYRIE,
NJORD, LOKI, BALDR, ERDA



FRAME: MATTE BLACK
AVAILABLE ON:
ODIN



FRAME: MATTE GRAY
AVAILABLE ON:
ODIN, THOR, DAGR, KVASIR, VALKYRIE,
NJORD, LOKI, BALDR



FRAME: WHITE
AVAILABLE ON:
ODIN, ERDA



FRAME: KRYPTEK® YETI™ CAMO
AVAILABLE ON:
DAGR, ERDA

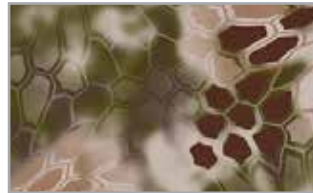

FRAME: KRYPTEK® HIGHLANDER™ CAMO
AVAILABLE ON:
ODIN, DAGR, BALDR



FRAME: KRYPTEK® TYPHON™ CAMO
AVAILABLE ON:
ODIN, THOR, DAGR, LOKI, BALDR, ERDA

**SKULLERZ®
LENS OPTIONS**

Ergodyne Skullerz® Safety Glasses are available in a variety of lens options ideally suited for a variety of tasks and light environments. See the specific model for lens availability. Choose from:



LENS: CLEAR //
CLEAR FOG-OFF™
VLT: 95%

INTENDED USES:
INDOOR; LOW LIGHT;
HAZY // CLOUDY



LENS: YELLOW
VLT: 91%

INTENDED USES:
INDOOR; LOW LIGHT;
HAZY // CLOUDY



LENS: INDOOR //
INDOOR//OUTDOOR
VLT: 50%

INTENDED USES:
INDOOR; NIGHTTIME; HAZY //
CLOUDY



LENS: SMOKE //
SMOKE FOG-OFF™
VLT: 16%

INTENDED USES:
OUTDOOR; BRIGHT LIGHT



LENS: COPPER
VLT: 13%

INTENDED USES:
OUTDOOR; BRIGHT LIGHT;
HIGH CONTRAST



LENS: SILVER MIRROR
VLT: 10%

INTENDED USES:
OUTDOOR; BRIGHT LIGHT; GLARE



LENS: HIGH-CONTRAST
PRECISION RED MIRROR
VLT: 21%

INTENDED USES:
OUTDOOR; BRIGHT LIGHT; GLARE;
HIGH CONTRAST



LENS: BLUE MIRROR
VLT: 17%

INTENDED USES:
OUTDOOR; BRIGHT LIGHT; GLARE



LENS: POLARIZED SMOKE
VLT: 12%

INTENDED USES:
OUTDOOR; BRIGHT LIGHT; GLARE;
WATER



LENS: POLARIZED COPPER
VLT: 14%

INTENDED USES:
OUTDOOR; BRIGHT LIGHT; GLARE;
HIGH CONTRAST; WATER



LENS: POLARIZED G15
VLT: 11%

INTENDED USES:
OUTDOOR; BRIGHT LIGHT; GLARE;
HIGH CONTRAST; WATER



NON-POLARIZED LENS



DARE THE GLARE Polarized lenses utilize a special filter coating to block out reflected light from below and glare from above, allowing only direct light to enter the field of vision, making them a great choice for applications around water, shiny equipment, or anywhere glare and reflection elimination are key to safety and comfort. Choose from polarized smoke, polarized copper, or polarized G15 (a unique and soothing green tinted lens first developed for the US Air Force). I can see clearly now the glare is gone.

TYPICAL LENS



GO ON, FOG-OFF™ For those applications with extreme temperatures (and drastic changes in temperature), maintain a clear field of vision by choosing clear or smoke lenses with Fog-Off™ anti-fog technology that will not wash or wear off. Meets ATSM 659 Resistance to Fogging test requirements.



SKULLERZ® LENS // FRAME AVAILABILITY

	Clear Clear Fog-Off™	Yellow	Indoor// Outdoor	Smoke Smoke Fog-Off™	Copper	Silver Mirror	Blue Mirror	HCP Red Mirror	Polarized Smoke	Polarized Copper	Polarized G15
Odin - Black	50000 50003 Fog-Off	50050	50080	50030 50033 Fog-Off	50020	50042	50092	50012	50031	50021	50071
Odin - Matte Black	50400	—	—	50430	—	50442	—	—	—	—	—
Odin - Matte Gray	50100 50103 Fog-Off	50150	50180	50130 50133 Fog-Off	—	—	—	—	50131	50121	—
Odin - White	—	—	—	50230	—	50242	—	—	50231	—	—
Odin - Kryptek® Typhon™ Camo	50500 50503 Fog-Off	50550	—	50530 50533 Fog-Off	50520	—	—	—	50531	50521	—
Odin - Kryptek® Highlander™ Camo	50300 50303 Fog-Off	50350	—	50330 50333 Fog-Off	50320	—	—	—	50331	50321	—
Thor - Black	51000 51003 Fog-Off	51050	51080	51030 51033 Fog-Off	51020	51042	51092	51012	51031	51021	51071
Thor - Matte Gray	51100 51103 Fog-Off	51150	51180	51130 51133 Fog-Off	—	—	—	—	51131	51121	—
Thor - Kryptek® Typhon™ Camo	51300 51303 Fog-Off	51350	—	51330 51333 Fog-Off	51320	—	—	—	51331	51321	—
Dagr - Black	52000 52003 Fog-Off	52050	52080	52030 52033 Fog-Off	52020	52042	52092	52012	52031	52021	52071
Dagr - Matte Gray	52100 52103 Fog-Off	52150	52180	52130 52133 Fog-Off	—	—	—	—	52131	52121	—
Dagr - Kryptek® Typhon™ Camo	52500 52503 Fog-Off	52550	—	52530 52533 Fog-Off	52520	—	—	—	52531	52521	—
Dagr - Kryptek® Yeti™ Camo	52600 52603 Fog-Off	52650	—	52630 52633 Fog-Off	52620	—	—	—	52631	52621	—
Dagr - Kryptek® Highlander™ Camo	52300 52303 Fog-Off	52350	—	52330 52333 Fog-Off	52320	—	—	—	52331	52321	—
Kvasir - Black	53000	53050	53080	53030	—	53042	—	—	—	—	—
Kvasir - Matte Gray	53100	53150	53180	53130	—	—	—	—	—	—	—
Valkyrie - Black	54000 54003 Fog-Off	54050	54080	54030 54033 Fog-Off	54020	54042	54092	54012	54031	54021	54071
Valkyrie - Matte Gray	54100 54103 Fog-Off	54150	54180	54130 54133 Fog-Off	—	—	—	—	54131	54121	—
Njord - Black	55000	55050	55080	55030	—	55042	—	—	—	—	—
Njord - Matte Gray	55100	55150	55180	55130	—	—	—	—	—	—	—
Loki - Black	56000 56003 Fog-Off	56050	56080	56030 56033 Fog-Off	56020	56042	56092	56012	56031	56021	—
Loki - Matte Gray	56100 56103 Fog-Off	56150	56180	56130 56133 Fog-Off	—	—	—	—	56131	56121	—
Baldr - Black	57000 57003 Fog-Off	57050	57080	57030 57033 Fog-Off	57020	57042	—	—	57031	57021	—
Baldr - Matte Gray	57100 57103 Fog-Off	57150	57180	57130 57133 Fog-Off	57120	—	—	—	57131	57121	—
Baldr - Kryptek® Highlander™ Camo	57300 57303 Fog-Off	57350	—	57330 57333 Fog-Off	57320	—	—	—	57331	57321	—
Baldr - Kryptek® Typhon™ Camo	57500 57503 Fog-Off	57550	—	57530 57533 Fog-Off	—	—	—	—	57531	57521	—
Erda - Black	58000 58003 Fog-Off	58050	58080	58030 58033 Fog-Off	58020	58042	—	—	58031	58021	—
Erda - White	58200 58203 Fog-Off	58250	—	58230 58233 Fog-Off	—	—	—	—	58231	58221	—
Erda - Kryptek® Typhon™ Camo	58500 58503 Fog-Off	58550	—	58530 58533 Fog-Off	58520	—	—	—	58531	58521	—
Erda - Kryptek® Yeti™ Camo	58600 58603 Fog-Off	58650	—	58630 58633 Fog-Off	58620	—	—	—	58631	58621	—
	Clear Clear Fog-Off™	Yellow	Indoor// Outdoor	Smoke Smoke Fog-Off™	Copper	Silver Mirror	Blue Mirror	HCP Red Mirror	Polarized Smoke	Polarized Copper	Polarized G15

SKULLERZ®
EYE & HEAD
PROTECTION

SKULLERZ® EYE PROTECTION:

EYE PROTECTION SERIES

DIFFERENTIATED BY DESIGN:

ANSI // MIL-PRF BALLISTIC IMPACT PROTECTION

All Skullerz® models in all lenses meet both ANSI Z87.1+ High Velocity and MIL-PRF 32342 Ballistic Impact protection requirements.

KRYPTEK® CAMO

Stand out by blending in with Kryptek® - the baddest camo patterns available.



ODIN

99.9% UV PROTECTION

All Skullerz® lenses, even clear, provide protection from 99.9% of harmful UVA // UVB // UVC rays.

LENS OPTIONS

Choose from up to 13 different lens options including glare-busting polarized and inherent Fog-Off™ anti-fog technology that won't wash or wear off.



DAGR

PATENTED BLADE STYLE DESIGN

Sleek blade style frame ensures excellent air flow and is designed to move easily from workplace to the weekend.





<p>FULL FRAME SAFETY GLASSES</p>		<p>ODIN</p> <p>ORDER MULTIPLE 12</p>
<ul style="list-style-type: none"> • Meets ANSI Z87.1+ and MIL-PRF 32432 Impact Requirements • Scratch-resistant lenses block 99.9% of harmful UV • Full-frame design with coinjection rubber temples • Non-slip rubber nose piece • Available Fog-Off™ technology won't wash, wear off • Premium polarized lenses available • Optional foam gasket insert to reduce debris entry • CSA Z94.3 coming soon <p>FRAME COLORS</p> <p>LENS OPTIONS</p>	<p>UPDATED FOR '16</p>	





// PATENTED





<p>LARGE FRAME SAFETY GLASSES</p>		<p>THOR</p>	<p>ORDER MULTIPLE 12</p>
<ul style="list-style-type: none"> • Meets ANSI Z87.1+ and MIL-PRF 32432 Impact Requirements • Scratch-resistant lenses block 99.9% of harmful UV • Full-frame design with coinjection rubber temples • Available Fog-Off™ technology won't wash, wear off • Premium polarized lenses available • CSA Z94.3 coming soon <p>FRAME COLORS</p> <p>LENS OPTIONS</p>			
<p>// PATENTED</p>			

<p>HALF FRAME SAFETY GLASSES</p>		<p>DAGR</p>	<p>ORDER MULTIPLE 12</p>
<ul style="list-style-type: none"> • Meets ANSI Z87.1+ and MIL-PRF 32432 Impact Requirements • Scratch-resistant lenses block 99.9% of harmful UV • Sleek blade frame with coinjection rubber temples • Non-slip rubber nose piece • Available Fog-Off™ technology won't wash, wear off • Premium polarized lenses available • CSA Z94.3 coming soon <p>FRAME COLORS</p> <p>LENS OPTIONS</p>			
<p>// PATENTED</p>			

<p>LARGE FRAME SAFETY GLASSES</p>		<p>BALDR</p>	<p>ORDER MULTIPLE 12</p>
<ul style="list-style-type: none"> • Meets ANSI Z87.1+ and MIL-PRF 32432 Impact Requirements • Scratch-resistant lenses block 99.9% of harmful UV • Large frame design for maximum coverage in style • Coinjection rubber temples • Available Fog-Off™ technology won't wash, wear off • Premium polarized lenses available • Optional foam gasket insert to reduce debris entry • CSA Z94.3 coming soon <p>FRAME COLORS</p> <p>LENS OPTIONS</p>			
<p>// PATENT PENDING</p>			

<p>MEDIUM FRAME SAFETY GLASSES</p>		<p>KVASIR</p>	<p>ORDER MULTIPLE 12</p>
<ul style="list-style-type: none"> • Meets ANSI Z87.1+ and MIL-PRF 32432 Impact Requirements • Scratch-resistant lenses block 99.9% of harmful UV • Versatile medium frame design with rubber temples • Temple accessory slot also improves air flow • Optional foam gasket insert to reduce debris entry <p>FRAME COLORS</p>  <p>LENS OPTIONS</p> 			
<p>// PATENTED</p>			

<p>MEDIUM FRAME SAFETY GLASSES</p>		<p>VALKYRIE</p>	<p>ORDER MULTIPLE 12</p>
<ul style="list-style-type: none"> • Meets ANSI Z87.1+ and MIL-PRF 32432 Impact Requirements • Scratch-resistant lenses block 99.9% of harmful UV • Smooth medium frame design with rubber temples • Available Fog-Off™ technology won't wash, wear off • Premium polarized lenses available • Optional foam gasket insert to reduce debris entry <p>FRAME COLORS</p>  <p>LENS OPTIONS</p> 			
<p>// PATENTED</p>			

<p>LARGE FRAME SAFETY GLASSES</p>		<p>ERDA</p>	<p>ORDER MULTIPLE 12</p>
<ul style="list-style-type: none"> • Meets ANSI Z87.1+, CSA Z94.3 and MIL-PRF 32432 Impact Requirements • Scratch-resistant lenses block 99.9% of harmful UV • Design specifically for female workers and wearers • Sleek temples; no rubber to snag in longer hair • Available Fog-Off™ technology won't wash, wear off • Premium polarized lenses available • Optional foam gasket insert to reduce debris entry <p>FRAME COLORS</p>  <p>LENS OPTIONS</p> 		 <div data-bbox="1402 1591 1482 1682" style="border: 2px solid black; padding: 2px; display: inline-block;"> <p>NEW FOR '16</p> </div>	
<p>// PATENT PENDING</p>			

<p>MEDIUM FRAME SAFETY GLASSES</p>		<p>NJORD</p>	<p>ORDER MULTIPLE 12</p>
<ul style="list-style-type: none"> • Meets ANSI Z87.1+ and MIL-PRF 32432 Impact Requirements • Scratch-resistant lenses block 99.9% of harmful UV • Stylish medium frame design • Great glasses at a super price point <p>FRAME COLORS </p> <p>LENS OPTIONS </p>			
<p>// PATENTED</p>			

<p>FULL FRAME SAFETY GLASSES / GOGGLES</p>		<p>LOKI</p>	<p>ORDER MULTIPLE 12</p>
<ul style="list-style-type: none"> • Meets ANSI Z87.1+ and MIL-PRF 32432 Impact Requirements • Scratch-resistant lenses block 99.9% of harmful UV • Removable rubber temples converts Loki to goggle • Available Fog-Off™ technology won't wash, wear off • Premium polarized lenses available • Removable foam gasket insert and strap included <p>FRAME COLORS </p> <p>LENS OPTIONS </p>			
<p>// PATENTED</p>			

MERCHANDISER AND DISPLAY OPTIONS

PLEASE, NO DROOLING ON THE CASE.

For our authorized sellers of these sweet specs – introducing Skullerz® merchandising and displays. From the countertop to the end cap, choose a 7-pair open waterfall display or go all Odin on it and get the King: a locking 12-pair spinning cabinet with integrated mirror and rear storage capacity. Fair warning: keep your Windex® handy for those saliva-soaked window gawkers.

MAYBE NO FREE LUNCH BUT A FREE DISPLAY?
WE CAN DO THAT. CALL OUR CRACKERJACK STAFF FOR MORE DETAILS.



SKULLERZ® EYE PROTECTION:

ACCESSORY SERIES

DIFFERENTIATED BY DESIGN:

BALLISTIC NYLON

A rugged ballistic nylon outer shell provides protection and tough, durable lair for your pair.

ZIPPER CLOSURE

Zipper closure for easy open and close.

MICROFIBER CLEANING CLOTH

All Skullerz® Cases include a 3216 microfiber cleaning cloth for scratch-free lens cleaning.



3225		<small>ORDER MULTIPLE</small> 1
BALLISTIC ZIPPER CASE		
		
<ul style="list-style-type: none"> • Ballistic nylon shell with soft brushed inside • Fits and stores all Skullerz® models • Zipper closure • Includes 3216 microfiber cleaning cloth 		
<small>ITEM #</small>	<small>SIZE</small>	<small>COLOR</small>
19225	—	Black

3222		<small>ORDER MULTIPLE</small> 1
ZIPPER CASE WITH CLIP		
		
<ul style="list-style-type: none"> • Nylon shell with soft brushed inside • Fits and stores all Skullerz® models • Convenient clip attaches to other gear • Zipper closure • Includes 3216 microfiber cleaning cloth 		
<small>ITEM #</small>	<small>SIZE</small>	<small>COLOR</small>
19222	—	Black

3216		<small>ORDER MULTIPLE</small> 12
MICROFIBER CLEANING CLOTH		
		
<ul style="list-style-type: none"> • Safely cleans lenses with scratching • Soft microfiber material • Embossed Ergodyne logo pattern 		
<small>ITEM #</small>	<small>SIZE</small>	<small>COLOR</small>
19216	—	Black

3218		<small>ORDER MULTIPLE</small> 12
MICROFIBER CLEANING BAG		
		
<ul style="list-style-type: none"> • Safely cleans lenses with scratching • Soft microfiber material • Embossed Ergodyne logo pattern 		
<small>ITEM #</small>	<small>SIZE</small>	<small>COLOR</small>
19218	—	Black

3200		ORDER MULTIPLE 24
COTTON EYEWEAR LANYARD		
		
<ul style="list-style-type: none"> • 100% cotton • Adjustable barrel slide • Slides over temple ends 		
ITEM #	SIZE	COLOR
19152	—	Black

	3215		ORDER MULTIPLE 24
BREAKAWAY COTTON EYEWEAR LANYARD			
			
<ul style="list-style-type: none"> • 100% cotton • Breakaway design • Adjustable barrel slide • Slides over temple ends 			
ITEM #	SIZE	COLOR	
19212	—	Black	

	3251		ORDER MULTIPLE 24
BREAKAWAY ROPE EYEWEAR LANYARD			
			
<ul style="list-style-type: none"> • 3mm braided nylon rope • Breakaway design • Slip-style attachment fits variety of temple sizes 			
ITEM #	SIZE	COLOR	
19342	—	Black	

3275		ORDER MULTIPLE 24
NEOPRENE EYEWEAR LANYARD		
		
<ul style="list-style-type: none"> • Lightweight neoprene • Slides over temple ends 		
ITEM #	SIZE	COLOR
19402	—	Black

3280		ORDER MULTIPLE 24
ELASTIC COIL EYEWEAR LANYARD		
		
<ul style="list-style-type: none"> • Stretchable nylon/elastic • Slip-style attachment fits variety of temple sizes 		
ITEM #	SIZE	COLOR
19280	—	Black

STRAPS		ORDER MULTIPLE 1			
STRAPS & GASKETS					
					
<ul style="list-style-type: none"> • Reduces dust and debris entry • Snaps in place at corners • Easily removes when not desired or for cleaning • Use alone or with elastic retainer strap 					
STRAP		GASKETS			
ITEM #	SIZE	STYLE	ITEM #	SIZE	STYLE
59991	—	Odin	50991	—	Odin
59991	—	Kvasir	53991	—	Kvasir
59991	—	Valkyrie	54991	—	Valkyrie
59991	—	Dagr	Included	—	Loki



SKULLERZ® HEAD PROTECTION

Let's face it, sometimes you can't avoid getting Three-Struck on the job – which usually means a sharp shot to the coconut. That's where Skullerz® Head Protection steps in to take the sting outta the bonk and turn accidental skullduggery into a minor cranial inconvenience. All models feature thermo-formed foam padding inside a removable, patented shell and a smooth lid with mesh venting for that comfy covert fit. Available in micro brim, short brim, and baseball brim-styling, there's even a built-in LED option for those bright bulbs who are tired of holding a flashlight in their teeth. Always thinking one step ahead.

HEAD PROTECTION // BUMP CAP SERIES



8950 Micro Brim



8950 Short Brim



8950 Long Brim



8955 Ranger Bump Cap



8960 LED Short Brim



8960 LED Long Brim



**BANG A GONG.
NOT YOUR HEAD.**

SKULLERZ®
EYE & HEAD
PROTECTION

SKULLERZ®

HEAD PROTECTION

SKULLERZ®:

BUMP CAP SERIES

DIFFERENTIATED BY DESIGN:



PATENTED SHELL

Flanged shell flexes for fit and comfort while ribs provide stability and support; innovative ventilation system allows the shell to breathe.

EN 812 COMPLIANT

All Skullerz® Bump Caps are tested and certified to the rigorous criteria of EN 812, the world's only bump cap standard.

COOL LID

Choose from 80mm, 50mm or 30mm (30mm in 8950 only) brim lengths in a variety of color options, all with mesh venting panels and reflective accents.



8960

LED LIGHTING TECHNOLOGY

Enhance worker productivity and ditch the bulky headlamp for 4 super-bright in-brim LEDs.

INNOVATIVE CLOSURE

Elastic // hook and loop closure stretches and is angled to provide a snug, secure fit.



FIND OUT MORE ABOUT THE TECHNOLOGY THAT GOES INTO THE FULL LINE OF ERGODYNE EYE & HEAD PROTECTION AT: WWW.ERGODYNE.COM

<p>BUMP CAP</p>		<p>8950</p>	<p>ORDER MULTIPLE 1</p>																																																														
<ul style="list-style-type: none"> • Removable impact-resistant shell with foam lining • Patented flanged design for comfort and air flow • Nylon or hi-vis polyester with reflective accents • Micro (30mm), short (50mm) or long (80mm) brim • EN 812-compliant patented design <table border="0"> <tr> <td colspan="3">8950: BLACK</td> <td colspan="3">8950: NAVY</td> <td colspan="3">8950: LIME</td> </tr> <tr> <td>ITEM #</td><td>SIZE</td><td>COLOR</td> <td>ITEM #</td><td>SIZE</td><td>COLOR</td> <td>ITEM #</td><td>SIZE</td><td>COLOR</td> </tr> <tr> <td>23342</td><td>Micro</td><td>Black</td> <td>23341</td><td>Micro</td><td>Navy</td> <td>23331</td><td>Micro</td><td>Lime</td> </tr> <tr> <td>23340</td><td>Short</td><td>Black</td> <td>23343</td><td>Short</td><td>Navy</td> <td>23333</td><td>Short</td><td>Lime</td> </tr> <tr> <td>23346</td><td>Short (XL)</td><td>Black</td> <td>23347</td><td>Short (XL)</td><td>Navy</td> <td>23335</td><td>Long</td><td>Lime</td> </tr> <tr> <td>23344</td><td>Long</td><td>Black</td> <td>23345</td><td>Long</td><td>Navy</td> <td></td><td></td><td></td> </tr> <tr> <td>23348</td><td>Long (XL)</td><td>Black</td> <td>23349</td><td>Long (XL)</td><td>Navy</td> <td></td><td></td><td></td> </tr> </table>		8950: BLACK			8950: NAVY			8950: LIME			ITEM #	SIZE	COLOR	ITEM #	SIZE	COLOR	ITEM #	SIZE	COLOR	23342	Micro	Black	23341	Micro	Navy	23331	Micro	Lime	23340	Short	Black	23343	Short	Navy	23333	Short	Lime	23346	Short (XL)	Black	23347	Short (XL)	Navy	23335	Long	Lime	23344	Long	Black	23345	Long	Navy				23348	Long (XL)	Black	23349	Long (XL)	Navy				<p>XL SHELL NOW AVAILABLE!</p>
8950: BLACK			8950: NAVY			8950: LIME																																																											
ITEM #	SIZE	COLOR	ITEM #	SIZE	COLOR	ITEM #	SIZE	COLOR																																																									
23342	Micro	Black	23341	Micro	Navy	23331	Micro	Lime																																																									
23340	Short	Black	23343	Short	Navy	23333	Short	Lime																																																									
23346	Short (XL)	Black	23347	Short (XL)	Navy	23335	Long	Lime																																																									
23344	Long	Black	23345	Long	Navy																																																												
23348	Long (XL)	Black	23349	Long (XL)	Navy																																																												
<p>// PATENTED</p>																																																																	

<p>BUMP CAP + LED LIGHTING TECHNOLOGY</p>		<p>8960</p>	<p>ORDER MULTIPLE 1</p>																																			
<ul style="list-style-type: none"> • Patented LED lighting technology built in under brim • Removable impact-resistant shell with foam lining • Patented flanged design for comfort and air flow • Nylon or hi-vis polyester with reflective accents • EN 812-compliant patented design <table border="0"> <tr> <td colspan="3">8960: BLACK</td> <td colspan="3">8960: NAVY</td> <td colspan="3">8960: LIME</td> </tr> <tr> <td>ITEM #</td><td>SIZE</td><td>COLOR</td> <td>ITEM #</td><td>SIZE</td><td>COLOR</td> <td>ITEM #</td><td>SIZE</td><td>COLOR</td> </tr> <tr> <td>23370</td><td>Short</td><td>Black</td> <td>23373</td><td>Short</td><td>Navy</td> <td>23377</td><td>Short</td><td>Lime</td> </tr> <tr> <td>23374</td><td>Long</td><td>Black</td> <td>23375</td><td>Long</td><td>Navy</td> <td>23379</td><td>Long</td><td>Lime</td> </tr> </table>		8960: BLACK			8960: NAVY			8960: LIME			ITEM #	SIZE	COLOR	ITEM #	SIZE	COLOR	ITEM #	SIZE	COLOR	23370	Short	Black	23373	Short	Navy	23377	Short	Lime	23374	Long	Black	23375	Long	Navy	23379	Long	Lime	<p>UPDATED FOR '16</p>
8960: BLACK			8960: NAVY			8960: LIME																																
ITEM #	SIZE	COLOR	ITEM #	SIZE	COLOR	ITEM #	SIZE	COLOR																														
23370	Short	Black	23373	Short	Navy	23377	Short	Lime																														
23374	Long	Black	23375	Long	Navy	23379	Long	Lime																														
<p>// PATENTED</p>																																						

<p>RANGER BUMP CAP</p>		<p>8955</p>	<p>ORDER MULTIPLE 1</p>																	
<ul style="list-style-type: none"> • Removable impact-resistant shell with foam lining • Patented flanged design for comfort and air flow • Nylon or hi-vis polyester with reflective accents • Wide brim for shade; breathable vented side panels • EN 812-compliant patented design <table border="0"> <tr> <td colspan="3">8955: HV LIME</td> <td colspan="3">8955: KHAKI</td> </tr> <tr> <td>ITEM #</td><td>SIZE</td><td>COLOR</td> <td>ITEM #</td><td>SIZE</td><td>COLOR</td> </tr> <tr> <td>22356</td><td>—</td><td>HV Lime</td> <td>22357</td><td>—</td><td>Khaki</td> </tr> </table>		8955: HV LIME			8955: KHAKI			ITEM #	SIZE	COLOR	ITEM #	SIZE	COLOR	22356	—	HV Lime	22357	—	Khaki	
8955: HV LIME			8955: KHAKI																	
ITEM #	SIZE	COLOR	ITEM #	SIZE	COLOR															
22356	—	HV Lime	22357	—	Khaki															
<p>// PATENTED</p>																				

SKULLERZ EYE & HEAD PROTECTION



PRODUCT



ACTIVITY



squids[®]

- » LANYARDS
- » ORGANIZERS

ARSENAL[™]

- » GEAR STORAGE
- » TOOL STORAGE



FOUR SIMPLE STEPS TO SAFER WORK.
OBJECTS AT HEIGHTS

PLAN YOUR WORK.

TRAPPING

Trapping refers to retrofitting a connection point onto a tool for a safer attachment point. Most tools do not come with a secure attachment point built into the tool. In these situations, a secure attachment point must be created.

**ONE STEP
 TOOL TRAPS**



3770



3780



3790

**TWO STEP
 TOOL TRAPS**



3700
 WEB TOOL TAILS



3755/3750
 TAPE TRAPS



3703/3103/3713
 ELASTIC TOOL TAILS



3755/3750
 TAPE TRAPS



3723/3724/3726
 COLD SHRINK TRAPS

TETHERING

Once all tools have a connection point the appropriate tethering solution can be selected. Consider the following factors to select the appropriate solution: weight of tool, type of connector(s) on lanyard, clearance, reach, and snag hazard.



**WRIST
 LANYARDS**

**RETRACTABLE
 LANYARDS**



**COILED
 LANYARDS**



**SHOCK ABSORBING
 ELASTIC LANYARDS**



**SPECIALTY
 LANYARDS**



WORK YOUR PLAN.

TOPPING

There are different ways of transporting equipment to heights and a variety of containers used to store the equipment while in transit. Regardless of what container is used, there are three critical best practices: hands free climbing, closed container, and weight rating.

CARRYING



AT HEIGHTS TOOL RIG:

- 3770
- 5516
- 5528

HOISTING

BUCKET:

5650T



BAG:

5843



TRAINING

Check out our comprehensive Objects at Heights training programs and collateral covering everything from basic training to certified Drop Cop. Check out www.ergodyne.com for more or email orders@ergodyne.com to get your schooling started.

LEARN HOW TO BECOME A DROP COPS® PRO...



LEARN TO TRAP, TETHER AND TOP IN OUR 52 PAGE BIBLE OF OBJECTS AT HEIGHTS SAFETY SOLUTIONS KNOWN AS THE DROP COPS® GUIDE.

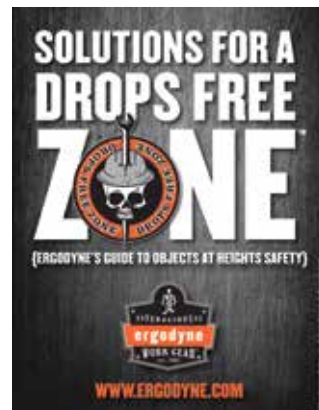



SQUIDS®
LANYARDS & WORKSITE ORGANIZERS

LOVE STINKS BUT GRAVITY HURTS.



SQUIDS® LANYARDS & ORGANIZERS

An apple dropping off a tree during a mathematician's summer idyll in the English countryside is one thing. Sledgehammers plummeting forty stories onto a busy worksite is a recipe for an ambulance. Spare yourself that sinking feeling with our smorgasbord of lanyards and organizers. Squids® Lanyard and Organizers trap, retract, extend and secure your gear so it's always in the last place you left it.

LANYARDS // CONNECTOR SERIES



3700 Tool Tails™ - Web Extension



3703 Tool Tails™ - Elastic Loop



3103 Detachable Loops



3750/3755 Heat Tape Trap

LANYARDS // TOOL LANYARD SERIES



3109 Triple-Locking Single Carabiner



3119 Triple-Locking Double



3108 Locking Single Carabiner



3101 Stainless Single Carabiner

LANYARDS // TOOL LANYARD SERIES



3100 Single Carabiner



3110 Double Carabiner



3104 Non-Conductive Lanyard



3130 Coil Tool Lanyard

LANYARDS // RETRACTOR SERIES



3000 Retractable Tool Lanyard



3025 Carabiner Attachment Pack



3001 Retractable Tool Lanyard



3026 Loop Attachment Pack

WORKSITE ORGANIZERS // GRABBER SERIES



3400 Dual Clip Grabber



3405 Belt Clip Grabber



3400MD Metal Detectable Grabber



3405MD Metal Detectable Grabber



3755 Self-adhering Tape Trap



3723 Cold Shrink Trap



3790 Shackle Trap



3770 Tape Measure Trap



3780 Power Tool Trap



3111 Stainless Dual Carabiner



3311 Stainless Twin Leg



3102 Detachable Single Carabiner



3114 Wrist Tool Lanyard



3116 Wrist Tool Lanyard



3115 Wrist Tool Lanyard



3175 Accessory Anchor

**LANYARDS
// ID LANYARDS
& SPECIALTY
SERIES**



3386 Arm Band ID / Badge Holder



3386HV HV Arm Band ID & Badge Holder



3150/3155 Hard Hat Lanyard



3157/3158 Hard Hat Lanyard



3410 Grabber Anchor-Suction



3415 Grabber Anchor-Magnet

**WORKSITE ORGANIZERS
// ACCESSORY SERIES**



3540 Large Locking Hook



3601 Drops Zone Tape



RETROFIT-ABILITY

If your tool doesn't have a clean connection point for tethering, use our retrofit Tool Tails™ and Tool Traps™ to create one. A quick application gives you an easy safe point to connect.

FUNCTIONAL LANYARD CHOICES

Options that include coils, retractables, and swiveling features give the user choices for specific tools and environments to reduce tangles, snags, and hang ups.



SAFETY WITHOUT SACRIFICE

Some tools require specific solutions that allow their primary purpose to function properly. Instrumentation and Power Tool Traps are built to give you tether ready tools without sacrifice.



FIND OUT MORE ABOUT THE TECHNOLOGY THAT GOES INTO THE FULL LINE OF ERGODYNE TOOL TETHER OPTIONS AT: WWW.ERGODYNE.COM

MAY THE “FORCE” NOT BE WITH YOU

Smart lanyard designs consider the user is often the anchor point. We don't want your tools getting you down, literally. Our elastic design is built to reduce the shock force the body feels, protecting the user as well as those below.

SQUIDS®
TETHERING SOLUTIONS:

**THE ANATOMY
OF TETHERING.**

STICK YOUR “NECK” OUT

Many tools have a “waist” or “neck” where a portion of the tool's profile gets smaller compared to thicker ends. This allows for more versatile retrofit connection points to be attached.

TOOL UP APPROPRIATELY

Choose tools that are durable and built for at-heights use. Wooden handles and other suspect designs are more likely to break and launch parts down on workers below.

SQUIDS® LANYARDS:

CONNECTOR SERIES

DIFFERENTIATED BY DESIGN:

SECURE HARDWARE

Fully enclosed plated hardware has no weak point. Made of durable metals that last, they are not bent or welded giving you confidence in the security of your retrofit connection.

3RD PARTY CERTIFIED WEIGHT RATINGS

Third-party certified with a safety factor of 2:1 to ensure the utmost in security. Connector systems applied with more than one component are tested and certified together as a system. We don't have to but we do!

DURABLE SYNTHETIC MATERIALS

Squids® Tool Tails™ and Tool Traps™ are made with high tensile strength webbing and abrasion resistant fabric to hold up in the toughest applications and prolong the life of the connector.

RETROFIT CONNECTOR VARIETY

We study and teach tool anatomy to give you options for retrofit connection points on tools that need 'em. One-step Tool Traps™ with built in connection points attach directly to the tool. Two step systems use a Tool Trap™ to capture a Tool Tail™ connection to the tool.

FUNCTIONAL MATERIALS AND DESIGNS

Squids® Tool Connectors are designed to NOT sacrifice your tool's primary use. Tool Traps™ and Tool Tails™ can be placed on the tool leaving mission critical parts of the tool ready to use. Specialty materials enhance grip and do not leave messy adhesives or residue on your tools.





3700

ORDER MULTIPLE

6

WEB TOOL TAILS™



MAXIMUM LOAD LIMIT

2

POUNDS

[1 KG]

PACKAGED (6) PER PACK

- Ultra strength nylon webbing
- Fully enclosed plated D-ring for secure attachment
- High tensile strength nylon thread
- Web catch with double stitch for more durable stop
- Used w/ Tool Trap™; creates retrofit tether point

ITEM #	SIZE	COLOR
19703	3.5" (9.0cm)	Black
19704	4.5" (11.5cm)	Orange
19705	5.5" (14.0cm)	Black
19706	6.5" (16.5cm)	Orange
19708	8.5" (21.5cm)	Black
19701	Variety Pack	Blk/Org (Includes 5, 1 of ea. size)

3103/3703/3713

ORDER MULTIPLE

6

ELASTIC TOOL TAILS™

MAXIMUM LOAD LIMIT

15

POUNDS

[6.8 KG]



MAXIMUM LOAD LIMIT

10

POUNDS

[4.5 KG]

MAXIMUM LOAD LIMIT

5

POUNDS

[2 KG]

3703 **3713** **3103**

- Stretch cord surrounded by tubular nylon webbing
- Fully enclosed plated O-ring for secure attachment
- Adjustable barrel lock for tool attachment
- Use as an anchor for belt, harness, or structure
- Used w/ Tool Trap™; creates retrofit tether point

3703: D-RING

ITEM #	SIZE	COLOR
19767	11" (28cm)	HV Lime
19769	18" (46cm)	HV Lime

3103: LANYARDS

ITEM #	SIZE	COLOR
19068	12.5" (32cm)	Black
19069	12.5" (32cm)	HV Lime

PACKAGED 3 PER PACK

3713: W/ SWIVEL

ITEM #	SIZE	COLOR
19765	11" (28cm)	HV Lime

// PATENT PENDING

	3755	ORDER MULTIPLE 1						
<p>SELF-ADHERING TAPE TRAP</p> <div style="display: flex; justify-content: space-between; align-items: center;"> <div style="border: 1px solid black; padding: 2px; font-weight: bold;">NEW FOR '16</div> <div style="border: 1px solid black; padding: 2px; font-weight: bold;">MAXIMUM LOAD LIMIT 8 POUNDS [3.6 KG]</div> </div> <ul style="list-style-type: none"> • Self-adhering requires no tools for application • No adhesives for easy replacement • Fiber glass reinforcement • Cut and puncture resistant • Added grip to handle of tools • Used w/ Tool Tail™; creates retrofit tether point <table border="1" style="width: 100%; border-collapse: collapse; margin-top: 10px;"> <thead> <tr> <th>ITEM #</th> <th>SIZE</th> <th>COLOR</th> </tr> </thead> <tbody> <tr> <td>19755</td> <td>1" x 12"</td> <td>Gray</td> </tr> </tbody> </table>			ITEM #	SIZE	COLOR	19755	1" x 12"	Gray
ITEM #	SIZE	COLOR						
19755	1" x 12"	Gray						

	3750	ORDER MULTIPLE 1												
<p>HEAT TAPE TRAP</p> <div style="display: flex; justify-content: space-between; align-items: center;"> <div style="border: 1px solid black; padding: 2px; font-weight: bold;">MAXIMUM LOAD LIMIT 15 POUNDS [6.8 KG]</div> </div> <p>AVAILABLE IN TWO ROLL LENGTHS</p> <ul style="list-style-type: none"> • Non-silicone based TPE material • No adhesives so it can be replaced without a mess • Set with heat application for secure attachment • Material content provides enhanced grip • Used w/ Tool Tail™; creates retrofit tether point <div style="display: flex; justify-content: space-around; margin-top: 10px;"> <div style="text-align: center;"> <p>3750S: 12FT ROLL</p> <table border="1" style="width: 100%; border-collapse: collapse;"> <thead> <tr> <th>ITEM #</th> <th>SIZE</th> <th>COLOR</th> </tr> </thead> <tbody> <tr> <td>19760</td> <td>1" x 12"</td> <td>Orange</td> </tr> </tbody> </table> </div> <div style="text-align: center;"> <p>3750M: 30FT ROLL</p> <table border="1" style="width: 100%; border-collapse: collapse;"> <thead> <tr> <th>ITEM #</th> <th>SIZE</th> <th>COLOR</th> </tr> </thead> <tbody> <tr> <td>19761</td> <td>1" x 30"</td> <td>Orange</td> </tr> </tbody> </table> </div> </div>			ITEM #	SIZE	COLOR	19760	1" x 12"	Orange	ITEM #	SIZE	COLOR	19761	1" x 30"	Orange
ITEM #	SIZE	COLOR												
19760	1" x 12"	Orange												
ITEM #	SIZE	COLOR												
19761	1" x 30"	Orange												

	3723/3724/3726	ORDER MULTIPLE 1												
<p>COLD SHRINK TRAP</p> <div style="display: flex; justify-content: space-between; align-items: center;"> <div style="border: 1px solid black; padding: 2px; font-weight: bold;">MAXIMUM LOAD LIMIT 5 POUNDS [2.3 KG]</div> </div> <div style="display: flex; justify-content: space-between; align-items: center; margin-top: 5px;"> <div style="border: 1px solid black; padding: 2px; font-weight: bold;">MAXIMUM LOAD LIMIT 10 POUNDS [4.5 KG]</div> <div style="border: 1px solid black; padding: 2px; font-weight: bold;">MAXIMUM LOAD LIMIT 15 POUNDS [6.8 KG]</div> </div> <p>AVAILABLE IN THREE SIZES</p> <ul style="list-style-type: none"> • 3M™ Cold Shrink technology requires no heat source • EPDM rubber resists acids and extreme temps • No other tools needed to create secure connection • Tool diameter range of 0.75" - 2.50" (1.9 - 6.4cm) • Used w/ Tool Tail™; creates retrofit tether point <div style="display: flex; justify-content: space-around; margin-top: 10px;"> <div style="text-align: center;"> <p>3723:</p> <table border="1" style="width: 100%; border-collapse: collapse;"> <thead> <tr> <th>ITEM #</th> <th>SIZE</th> </tr> </thead> <tbody> <tr> <td>19723</td> <td>3" (7.6cm)</td> </tr> </tbody> </table> </div> <div style="text-align: center;"> <p>3724:</p> <table border="1" style="width: 100%; border-collapse: collapse;"> <thead> <tr> <th>ITEM #</th> <th>SIZE</th> </tr> </thead> <tbody> <tr> <td>19724</td> <td>4" (10.2cm)</td> </tr> </tbody> </table> </div> <div style="text-align: center;"> <p>3726:</p> <table border="1" style="width: 100%; border-collapse: collapse;"> <thead> <tr> <th>ITEM #</th> <th>SIZE</th> </tr> </thead> <tbody> <tr> <td>19726</td> <td>6" (15.3cm)</td> </tr> </tbody> </table> </div> </div>			ITEM #	SIZE	19723	3" (7.6cm)	ITEM #	SIZE	19724	4" (10.2cm)	ITEM #	SIZE	19726	6" (15.3cm)
ITEM #	SIZE													
19723	3" (7.6cm)													
ITEM #	SIZE													
19724	4" (10.2cm)													
ITEM #	SIZE													
19726	6" (15.3cm)													

// PATENT PENDING

	3770	ORDER MULTIPLE 1						
<p>TAPE MEASURE TRAP</p> <ul style="list-style-type: none"> • Polyester main material • Hook and loop straps secure tape measure • Nickel-plated belt clip • Zinc-plated cast D-Ring • Fits most standard tape measures <table border="1" style="width: 100%; border-collapse: collapse; margin-top: 10px;"> <thead> <tr> <th>ITEM #</th> <th>SIZE</th> <th>COLOR</th> </tr> </thead> <tbody> <tr> <td>19770</td> <td>—</td> <td>Orange</td> </tr> </tbody> </table>			ITEM #	SIZE	COLOR	19770	—	Orange
ITEM #	SIZE	COLOR						
19770	—	Orange						

// PATENT PENDING

	3780	ORDER MULTIPLE 1									
<p>POWER TOOL TRAP</p> <ul style="list-style-type: none"> • 1000D nylon with water-resistant backing • Hook and loop straps secure power tool battery • Nickel-plated cast D-ring • Prevents battery from becoming a dropped object • Fits most power tool batteries <table border="1" style="width: 100%; border-collapse: collapse; margin-top: 10px;"> <thead> <tr> <th>ITEM #</th> <th>SIZE</th> <th>COLOR</th> </tr> </thead> <tbody> <tr> <td>19782</td> <td>S</td> <td>Black</td> </tr> <tr> <td>19784</td> <td>L</td> <td>Black</td> </tr> </tbody> </table>			ITEM #	SIZE	COLOR	19782	S	Black	19784	L	Black
ITEM #	SIZE	COLOR									
19782	S	Black									
19784	L	Black									

// PATENT PENDING

	3790	ORDER MULTIPLE 1															
<p>SHACKLE TRAPS</p> <div style="display: flex; justify-content: space-between; align-items: center;"> <div style="border: 1px solid black; padding: 2px; font-weight: bold;">MAXIMUM LOAD LIMIT 15 POUNDS [6.8 KG]</div> <div style="text-align: right;">PACKAGED 2 PER PACK</div> </div> <ul style="list-style-type: none"> • Stainless steel (#304) material • One step retrofit attachment for tethering point • Connects around midsection of a waisted tool • Secure by adding a drop of adhesive and tightening <table border="1" style="width: 100%; border-collapse: collapse; margin-top: 10px;"> <thead> <tr> <th>ITEM #</th> <th>SIZE</th> <th>COLOR</th> </tr> </thead> <tbody> <tr> <td>19792</td> <td>S</td> <td>Stainless Steel</td> </tr> <tr> <td>19793</td> <td>M</td> <td>Stainless Steel</td> </tr> <tr> <td>19794</td> <td>L</td> <td>Stainless Steel</td> </tr> <tr> <td>19795</td> <td>XL</td> <td>Stainless Steel</td> </tr> </tbody> </table>			ITEM #	SIZE	COLOR	19792	S	Stainless Steel	19793	M	Stainless Steel	19794	L	Stainless Steel	19795	XL	Stainless Steel
ITEM #	SIZE	COLOR															
19792	S	Stainless Steel															
19793	M	Stainless Steel															
19794	L	Stainless Steel															
19795	XL	Stainless Steel															

squids
LANYARDS &
ORGANIZERS

SQUIDS® LANYARDS:

CARABINER VARIETY AND SECURITY

A variety of carabiner options give you what you need for your environment - lightweight aluminum, stainless steel, non-locking, and self-locking are some of the options available to give you jobsite flexibility.

LANYARD SERIES

DIFFERENTIATED BY DESIGN:

SHOCK ABSORBING PROPERTIES

Stretch cord models exhibit shock absorbing properties limiting the force the body or other anchoring points feel when a drop occurs.

DURABLE LANYARD BODY

Whether high tensile strength webbing, reinforced stitching, or aircraft cable, Squids® Tool and Equipment Lanyards are made to hold up to the environment as well as a drop within it.

3RD PARTY CERTIFIED WEIGHT RATINGS

Squids® Lanyards are dynamically drop tested and third-party certified with a safety factor of 2:1. We don't have to but we do!



CAPTIVE EYE CARABINERS

Carabiners are designed with captive eyes to catch and hold webbing so it doesn't interfere with the connector's gate and will never be removed.

3100

ORDER MULTIPLE
6

SINGLE CARABINER TOOL LANYARD

- Energy absorbing cord with tubular nylon webbing
- Single action aluminum carabiner
- Adjustable barrel lock for tool attachment
- Reflective accent for higher visibility
- Lock stitching at both ends for extra security

ITEM #	SIZE	COLOR
19002	Std. 35" - 42" (89cm - 110cm)	Black
19012	Ext. 42" - 54" (110cm - 140cm)	Black
19003	Std. 35" - 42" (89cm - 110cm)	HV Lime
19013	Ext. 42" - 54" (110cm - 140cm)	HV Lime

// PATENTED

3110

ORDER MULTIPLE
6

DUAL CARABINER TOOL LANYARD

- Energy absorbing cord with tubular nylon webbing
- Single action aluminum carabiner
- Reflective accent for higher visibility
- Lock stitching at both ends for extra security

ITEM #	SIZE	COLOR
19022	Std. 35" - 42" (89cm - 110cm)	Black
19032	Ext. 42" - 54" (110cm - 140cm)	Black
19023	Std. 35" - 42" (89cm - 110cm)	HV Lime
19033	Ext. 42" - 54" (110cm - 140cm)	HV Lime

3102

ORDER MULTIPLE
6

DETACHABLE SINGLE CARABINER TOOL LANYARD

EXTRA TAILS (3103)

ITEM #	COLOR
19068	Black
19069	HV Lime

- Energy absorbing cord with tubular nylon webbing
- Single action aluminum carabiner
- Adjustable barrel lock for tool attachment
- Modular connecting buckle for exchanging tools
- Lock stitching at both ends for extra security

ITEM #	SIZE	COLOR
19064	Std. 35" - 42" (89cm - 110cm)	Black
19074	Ext. 42" - 54" (110cm - 140cm)	Black
19065	Std. 35" - 42" (89cm - 110cm)	HV Lime
19075	Ext. 42" - 54" (110cm - 140cm)	HV Lime

3101

ORDER MULTIPLE
6

SINGLE SS SCREWGATE CARABINER LANYARD

MAXIMUM LOAD LIMIT
15 POUNDS
[6.8 KG]

- Energy absorbing cord with tubular nylon webbing
- Manual locking stainless steel (SS) carabiners (#304)
- Adjustable barrel lock for tool attachment
- Reflective accent for higher visibility
- Lock stitching at both ends for extra security

ITEM #	SIZE	COLOR
19007	Std. 35" - 42" (89cm - 110cm)	HV Lime
19017	Ext. 42" - 54" (110cm - 140cm)	HV Lime

3111

ORDER MULTIPLE
6

DUAL SS SCREWGATE CARABINER LANYARD

MAXIMUM LOAD LIMIT
15 POUNDS
[6.8 KG]

- Energy absorbing cord with tubular nylon webbing
- Manual locking stainless steel (SS) carabiners (#304)
- Reflective accent for higher visibility
- Lock stitching at both ends for extra security

ITEM #	SIZE	COLOR
19027	Std. 35" - 42" (89cm - 110cm)	HV Lime
19037	Ext. 42" - 54" (110cm - 140cm)	HV Lime

3311

ORDER MULTIPLE
1

SS SCREWGATE TRIPLE CARABINER - TWIN LEG

MAXIMUM LOAD LIMIT
15 POUNDS
[6.8 KG]

- Energy absorbing cord with tubular nylon webbing
- Manual locking stainless steel (SS) carabiners (#304)
- Twin leg for two tools or 100% tie-off of one tool
- Reflective accent for higher visibility
- Lock stitching at both ends for extra security

ITEM #	SIZE	COLOR
19083	Std. 35" - 42" (89cm - 110cm)	HV Lime

3108

ORDER MULTIPLE
6

HEAVY-DUTY SELF LOCKING CARABINER LANYARD

MAXIMUM LOAD LIMIT
10 POUNDS
[4.5 KG]

- Energy absorbing cord with tubular nylon webbing
- Heavy-duty (500kgf) self-locking carabiner
- Adjustable barrel lock for tool attachment
- Reflective accent for higher visibility
- Lock stitching at both ends for extra security

ITEM #	SIZE	COLOR
19008	Short 28" - 35" (71cm - 89cm)	HV Lime

3109

ORDER MULTIPLE
1

HEAVY-DUTY TRIPLE LOCKING SINGLE CARABINER

MAXIMUM LOAD LIMIT
15 POUNDS
[6.8 KG]

- Energy absorbing cord with tubular nylon webbing
- Triple-locking (8KN) carabiner with swivel
- Adjustable barrel lock for tool attachment
- Reflective accent for higher visibility
- Lock stitching at both ends for extra security

ITEM #	SIZE	COLOR
19009	Std. 35" - 42" (89cm - 110cm)	HV Lime
19019	Ext. 42" - 54" (110cm - 140cm)	HV Lime

3119

ORDER MULTIPLE
1

HEAVY-DUTY TRIPLE LOCKING DUAL CARABINER

MAXIMUM LOAD LIMIT
20 POUNDS
[9 KG]

- Energy absorbing cord with tubular nylon webbing
- Triple-locking (8KN) carabiner with swivel
- Reflective accent for higher visibility
- Lock stitching at both ends for extra security

ITEM #	SIZE	COLOR
19029	Std. 35" - 42" (89cm - 110cm)	HV Lime
19039	Ext. 42" - 54" (110cm - 140cm)	HV Lime

			<h1>3104</h1>	<small>ORDER MULTIPLE</small> 6						
<h3>NON-CONDUCTIVE/NON-MARRING TOOL LANYARD</h3>										
										
<ul style="list-style-type: none"> • Energy absorbing cord with tubular nylon webbing • Non-conductive and non-marring dual loop design • Modular connecting buckle for exchanging tools • Adjustable barrel lock for tool attachment • Lock stitching at both ends for extra security 										
<table border="1"> <thead> <tr> <th>ITEM #</th> <th>SIZE</th> <th>COLOR</th> </tr> </thead> <tbody> <tr> <td>19104</td> <td>Std.</td> <td>HV Lime</td> </tr> </tbody> </table>					ITEM #	SIZE	COLOR	19104	Std.	HV Lime
ITEM #	SIZE	COLOR								
19104	Std.	HV Lime								

			<h1>3130</h1>	<small>ORDER MULTIPLE</small> 1												
<h3>COIL TOOL LANYARD</h3>																
																
<ul style="list-style-type: none"> • Constructed with PU covered aircraft cable • Stainless steel carabiners (#304) • Coil design prevents snag and tangle hazards • Swiveling design prevents tangles and fast recoil • Extended length 51" (129cm) 																
<table border="1"> <thead> <tr> <th>ITEM #</th> <th>SIZE</th> <th>STYLE</th> <th>COLOR</th> </tr> </thead> <tbody> <tr> <td>19130</td> <td>S</td> <td>Coil</td> <td>HV Lime</td> </tr> <tr> <td>19131</td> <td>M</td> <td>Coil</td> <td>Orange</td> </tr> </tbody> </table>					ITEM #	SIZE	STYLE	COLOR	19130	S	Coil	HV Lime	19131	M	Coil	Orange
ITEM #	SIZE	STYLE	COLOR													
19130	S	Coil	HV Lime													
19131	M	Coil	Orange													
// PATENT PENDING																

			<h1>3175</h1>	<small>ORDER MULTIPLE</small> 6						
<h3>ACCESSORY ANCHOR</h3>										
										
<ul style="list-style-type: none"> • Heavy-duty 45mm polyester webbing • Nickel-plated iron D-Ring • 840D nylon wear protector sleeve • Not for climbing or fall arrest 										
<table border="1"> <thead> <tr> <th>ITEM #</th> <th>SIZE</th> <th>COLOR</th> </tr> </thead> <tbody> <tr> <td>19175</td> <td>—</td> <td>HV Lime</td> </tr> </tbody> </table>					ITEM #	SIZE	COLOR	19175	—	HV Lime
ITEM #	SIZE	COLOR								
19175	—	HV Lime								

			<h1>3115</h1>	<small>ORDER MULTIPLE</small> 6												
<h3>WRIST TOOL LANYARD</h3>																
																
<ul style="list-style-type: none"> • Polyester webbing cuff secures to wrist • Energy absorbing ribbed pull cord • Adjustable barrel lock for tool attachment • Short length improves the drop clearance needed • Wrist Measurement: S/M 5" (13cm) – 7" (18cm) • Wrist Measurement: L/XL 7" (18cm) – 8 ½" (22cm) 																
<table border="1"> <thead> <tr> <th>ITEM #</th> <th>SIZE</th> <th>STYLE</th> <th>COLOR</th> </tr> </thead> <tbody> <tr> <td>19042</td> <td>S/M</td> <td>Adj.</td> <td>Black</td> </tr> <tr> <td>19052</td> <td>L/XL</td> <td>Adj.</td> <td>Black</td> </tr> </tbody> </table>					ITEM #	SIZE	STYLE	COLOR	19042	S/M	Adj.	Black	19052	L/XL	Adj.	Black
ITEM #	SIZE	STYLE	COLOR													
19042	S/M	Adj.	Black													
19052	L/XL	Adj.	Black													

			<h1>3114</h1>	<small>ORDER MULTIPLE</small> 6								
<h3>PULL-ON WRIST TOOL LANYARD - CARABINER</h3>												
												
<ul style="list-style-type: none"> • Elastic maintains snug fit • Pull-on design provides easy on/off • One size fits all • Stainless steel (#304) carabiner • Tuck-away pocket to keep connector when not in use 												
<table border="1"> <thead> <tr> <th>ITEM #</th> <th>SIZE</th> <th>STYLE</th> <th>COLOR</th> </tr> </thead> <tbody> <tr> <td>19056</td> <td>—</td> <td>Adj.</td> <td>Black</td> </tr> </tbody> </table>					ITEM #	SIZE	STYLE	COLOR	19056	—	Adj.	Black
ITEM #	SIZE	STYLE	COLOR									
19056	—	Adj.	Black									
// PATENT PENDING												

			<h1>3116</h1>	<small>ORDER MULTIPLE</small> 6								
<h3>PULL-ON WRIST TOOL LANYARD - BUCKLE</h3>												
												
<ul style="list-style-type: none"> • Elastic maintains snug fit • Pull-on design provides easy on/off • One size fits all • Modular quick connecting buckle • Tuck-away pocket to keep connector when not in use 												
<table border="1"> <thead> <tr> <th>ITEM #</th> <th>SIZE</th> <th>STYLE</th> <th>COLOR</th> </tr> </thead> <tbody> <tr> <td>19057</td> <td>—</td> <td>Buckle</td> <td>Black</td> </tr> </tbody> </table>					ITEM #	SIZE	STYLE	COLOR	19057	—	Buckle	Black
ITEM #	SIZE	STYLE	COLOR									
19057	—	Buckle	Black									
// PATENT PENDING												

SQUIDS® LANYARDS:

RETRACTOR SERIES

DIFFERENTIATED BY DESIGN:



ABS THERMOPLASTIC HOUSING

Outer shell of retractor holds up to the elements and the beating it takes hanging onto tools you cherish.

3001

SELF-SETTING LENGTH

Self-setting pawls set desired lanyard length and use a safe one-handed operation to release and retract back into the housing.

MODULAR DESIGN

Tool Tails™ connect to various tools and exchange quickly and securely allowing you to use multiple tools without a tangled mess.

		3000 3025	ORDER MULTIPLE 1
RETRACTABLE TOOL LANYARD - CARABINER			
3000 		3025 	
<ul style="list-style-type: none"> • Self-setting pawls set desired lanyard length • Modular connecting buckle for exchanging tools • Plated swiveling ring for 360 degree rotation • Manual locking stainless steel carabiners (#304) • Technora cord for ultimate strength and durability 			
3000: CARABINER		3025: EXTRA TAILS (3 PK.)	
ITEM #	COLOR	ITEM #	COLOR
19300	Black	19325	Black
// PATENTED			

		3001 3026	ORDER MULTIPLE 1
RETRACTABLE TOOL LANYARD - LOOP			
3001 		3026 	
<ul style="list-style-type: none"> • Self-setting pawls set desired lanyard length • Modular connecting buckle for exchanging tools • Plated swiveling ring for 360 degree rotation • Loop and manual locking stainless carabiner (#304) • Technora cord for ultimate strength and durability 			
3001: LOOP		3026: EXTRA TAILS (3 PK.)	
ITEM #	COLOR	ITEM #	COLOR
19301	Black	19326	Black
// PATENTED			

		<h1>3150</h1>	ORDER MULTIPLE 6
<h3>ELASTIC HARD HAT LANYARD-BUCKLE</h3>			
<ul style="list-style-type: none"> • Comfortable high stretch elastic material • Easily attaches to hard hats and other headwear • Double lock plastic buckle attaches to harness 			
ITEM #	SIZE	COLOR	
19150	21.5"	HV Lime	

		<h1>3155</h1>	ORDER MULTIPLE 6
<h3>ELASTIC HARD HAT LANYARD-CLAMP</h3>			
<ul style="list-style-type: none"> • Comfortable high stretch elastic material • Easily attaches to hard hats and other headwear • Quick connect clamp attaches securely to fabric 			
ITEM #	SIZE	COLOR	
19155	23"	HV Lime	

		<h1>3386</h1>	ORDER MULTIPLE 6
<h3>ID & BADGE HOLDER</h3>			
<ul style="list-style-type: none"> • Durable vinyl construction • Products ID badge • Fits 4.75" x 3" (12.1cm x 7.6cm) ID 			
ITEM #	SIZE	COLOR	
19950	12" - 18"	Black	

		<h1>3157</h1>	ORDER MULTIPLE 6
<h3>COIL HARD HAT LANYARD-BUCKLE</h3>			
<ul style="list-style-type: none"> • Low profile durable plastic coil • Easily attaches to hard hats and other headwear • Coil design prevents snag and tangle hazards • Double lock plastic buckle attaches to harness 			
ITEM #	SIZE	COLOR	
19156	18"	Black	
19157	18"	HV Lime	

		<h1>3158</h1>	ORDER MULTIPLE 6
<h3>COIL HARD HAT LANYARD-CLAMP</h3>			
<ul style="list-style-type: none"> • Low profile durable plastic coil • Easily attaches to hard hats and other headwear • Coil design prevents snag and tangle hazards • Quick connect clamp attaches securely to fabric 			
ITEM #	SIZE	COLOR	
19158	13"	Black	
19159	13"	HV Lime	

		<h1>3386_{HV}</h1>	ORDER MULTIPLE 6
<h3>HI-VIS ID & BADGE HOLDER</h3>			
<ul style="list-style-type: none"> • Durable vinyl construction • Hi-Visibility elastic armband with hook and loop • Products ID badge • Fits 4.75" x 3" (12.1cm x 7.6cm) ID 			
ITEM #	SIZE	COLOR	
19951	12" - 18"	HV Orange	

SQUIDS® LANYARD SELECT-O-MATIC

Maximum working capacity is calculated by third party load testing to a safety factor of 2.

Model	CAPACITY		LANYARD			CONNECTORS				
	LBS	KGs	Style	Modular	Single/Twin Leg	Connector A		Connector B		Swivel
						Material	Connection	Material	Connection	
3000	1	0.5	Retractable	Yes	Single	Stainless	Manual Lock	Stainless	Manual Lock	Yes
3001	2	0.9	Retractable	Yes	Single	Stainless	Manual Lock	Loop	Choke	Yes
3100	10	4.6	Shock Absorbing Elastic	No	Single	Aluminum	Non Locking	Loop	Choke	No
3101	15	6.8	Shock Absorbing Elastic	No	Single	Stainless	Manual Lock	Loop	Choke	No
3102	5	2.3	Shock Absorbing Elastic	Yes	Single	Aluminum	Non Locking	Loop	Choke	No
3104	5	2.3	Shock Absorbing Elastic	Yes	Single	Loop	Choke	Loop	Choke	No
3108	10	4.6	Shock Absorbing Elastic	No	Single	Aluminum	Self Lock Dbl Action	Loop	Choke	No
3109	15	6.8	Shock Absorbing Elastic	No	Single	Aluminum	Self Lock Tri-Action	Loop	Choke	Yes
3110	10	4.6	Shock Absorbing Elastic	No	Single	Aluminum	Non Locking	Aluminum	Non Locking	No
3111	15	6.8	Shock Absorbing Elastic	No	Single	Stainless	Manual Lock	Stainless	Manual Lock	No
3119	20	9.0	Shock Absorbing Elastic	No	Single	Aluminum	Self Lock Tri-Action	Aluminum	Self Lock Tri-Action	Yes
3130S	2	0.9	Coiled Cable	No	Single	Stainless	Manual Lock	Stainless	Manual Lock	No
3130M	5	2.3	Coiled Cable	No	Single	Stainless	Manual Lock	Stainless	Manual Lock	No
3311	15	6.8	Shock Absorbing Elastic	No	Twin	Stainless	Manual Lock	Stainless	Manual Lock	No
3114	3	1.4	Wrist	No	Single	Nylon Strap	Wrist Cuff	Stainless	Manual Lock	Yes
3115	2	0.9	Wrist	No	Single	Nylon Strap	Wrist Cuff	Loop	Choke	Yes
3116	3	1.4	Wrist	Yes	Single	Nylon Strap	Wrist Cuff	Loop	Choke	Yes
3150	2	0.9	Specialty	No	Single	Polyester	Loop	Polypropylene	Buckle	No
3155	2	0.9	Specialty	No	Single	Polyester	Loop	Polypropylene	Clamp	No
3157	2	0.9	Specialty	No	Single	Polyester	Loop	Polypropylene	Buckle	No
3158	2	0.9	Specialty	No	Single	Polyester	Loop	Polypropylene	Clamp	No

SQUIDS® LANYARD LINEUP



WRIST LANYARDS



RETRACTABLE LANYARDS



COILED LANYARDS



SHOCK ABSORBING ELASTIC LANYARDS



SPECIALTY LANYARDS

SQUIDS® CONNECTOR CLASS



CONNECTOR STYLE:
Triple Action with Swivel



CONNECTOR STYLE:
Self-Locking



CONNECTOR STYLE:
Manual Lock Stainless Steel

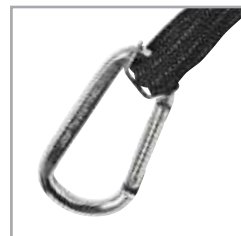

CONNECTOR STYLE:
Single Action



CONNECTOR STYLE:
Choked Loop

SQUIDS® ORGANIZERS:

GRABBER & ACC. SERIES

DIFFERENTIATED BY DESIGN:

MODULAR ANCHORING OPTIONS

Offering a variety of mounts to anchor the grabber to your body or to a static anchor point keeping your gear where you need it, when you need it.

BREAKAWAY DESIGN

All Squids® Grabbers have a breakaway design that disconnects immediately if caught on or in something dangerous - all without damaging the grabber.

INDEPENDENT OPERATION

No matter what mount you choose, the grabber itself can be removed and used independently, attaching to D-rings, keychains, and a variety of your own inherent anchor points.

PATENTED GRABBER DESIGN

Grabber clip holds onto PPE, tools, accessories, and other items preventing dropped, lost, and foreign object concerns.

GRABBERS® COLORS:



Black

Blue



Orange

Lime



Red

Pink



3415

	3410	ORDER MULTIPLE 6
GRABBER - SUCTION CUP ANCHOR MOUNT		
<ul style="list-style-type: none"> • Suction cup mounts to clean flat surfaces • Pull tab allows easy removal from surface • Anchor to carts, machinery, desks, and equipment • Dielectric / non-conductive material • Grabber disconnects allowing independent use 		
ITEM #	SIZE	COLOR
19321	—	Black
// PATENTED		

	3415	ORDER MULTIPLE 6
GRABBER - MAGNET ANCHOR MOUNT		
<ul style="list-style-type: none"> • Magnetic anchor mounts to ferromagnetic surfaces • Soft overmold grabs surface preventing slippage • Anchor to carts, machinery, desks, and equipment • Encapsulated magnet protects against corrosion • Grabber disconnects allowing independent use 		
ITEM #	SIZE	COLOR
19322	—	Black
// PATENTED		

3400

ORDER MULTIPLE
6

GRABBER - DUAL CLIP MOUNT

- Clips to clothing, belts, tool belts, and D-rings
- Holds PPE, tools, accessories, and other items
- Prevents dropped objects and foreign material
- Durable, ultra-resilient acetal copolymer
- Dielectric / non-conductive material

ITEM #	SIZE	COLOR	ITEM #	SIZE	COLOR
19112	—	Black	19119	—	HV Lime
19117	—	Blue	19113	—	Red
19118	—	HV Orange	19114	—	Pink

// PATENTED

3405

ORDER MULTIPLE
6

GRABBER - BELT CLIP MOUNT

- Clips to belts, tool belts, webbing, and pants
- Holds PPE, tools, accessories, and other items
- Prevents dropped objects and foreign material
- Durable, ultra-resilient acetal copolymer
- Dielectric / non-conductive material

ITEM #	SIZE	COLOR	ITEM #	SIZE	COLOR
19122	—	Black	19129	—	HV Lime
19127	—	Blue	19123	—	Red
19128	—	HV Orange	19124	—	Pink

// PATENTED

3540

ORDER MULTIPLE
6

TIE HOOK-LOCKING HOOK

MAXIMUM LOAD LIMIT
44
POUNDS
[20 KG]

- Large locking hook with 360° swivel (1.5"/38mm)
- Reusable sliding belt lock mechanism
- High tensile strength, weather resistant nylon 66
- Temp range: -40°F - 176°F (-40°C - 80°C)
- Resistant to oil, salt, solvents, and alkali

ITEM #	SIZE	COLOR
33402	3540S: 11.8" (30cm) belt	HV Orange
33403	3540M: 15.8" (40cm) belt	HV Orange
33404	3540L: 19.7" (50cm) belt	HV Orange

// PATENTED

3400_{MD}

ORDER MULTIPLE
6

METAL DETECTABLE GRABBER - DUAL CLIP MOUNT

- Clips to clothing, belts, tool belts, and D-rings
- Holds PPE, tools, accessories, and other items
- Metal detectable material alerts quality control
- Entire piece impregnated with metallic powder
- Deep blue color signals metal detectability

ITEM #	SIZE	COLOR
19132	—	Deep Blue

// PATENTED

3405_{MD}

ORDER MULTIPLE
6

METAL DETECTABLE GRABBER - BELT CLIP MOUNT

- Clips to belts, tool belts, webbing, and pants
- Holds PPE, tools, accessories, and other items
- Metal detectable material alerts quality control
- Entire piece impregnated with metallic powder
- Deep blue color signals metal detectability

ITEM #	SIZE	COLOR
19142	—	Deep Blue

// PATENTED

3601

ORDER MULTIPLE
1

DROPS ZONE™ TAPE

- "CAUTION DROPS ZONE" message repeating
- Durable 4 mil (0.1mm) thickness
- Black text on orange tape announces safety risk
- Easily put up and torn down for jobsite marking
- 3" wide (7.6cm)

ITEM #	SIZE	COLOR	ITEM #	SIZE	COLOR
3601S: 300ft. (91.4m)			3601L: 1000ft. (304.8m)		
19503	—	HV Orange	19501	—	HV Orange



ANOKA
CHAMPLIN
FIRE DEPT

September 11, 2001



GOD BLESS
AMERICA

ARSENAL[®]

GEAR STORAGE

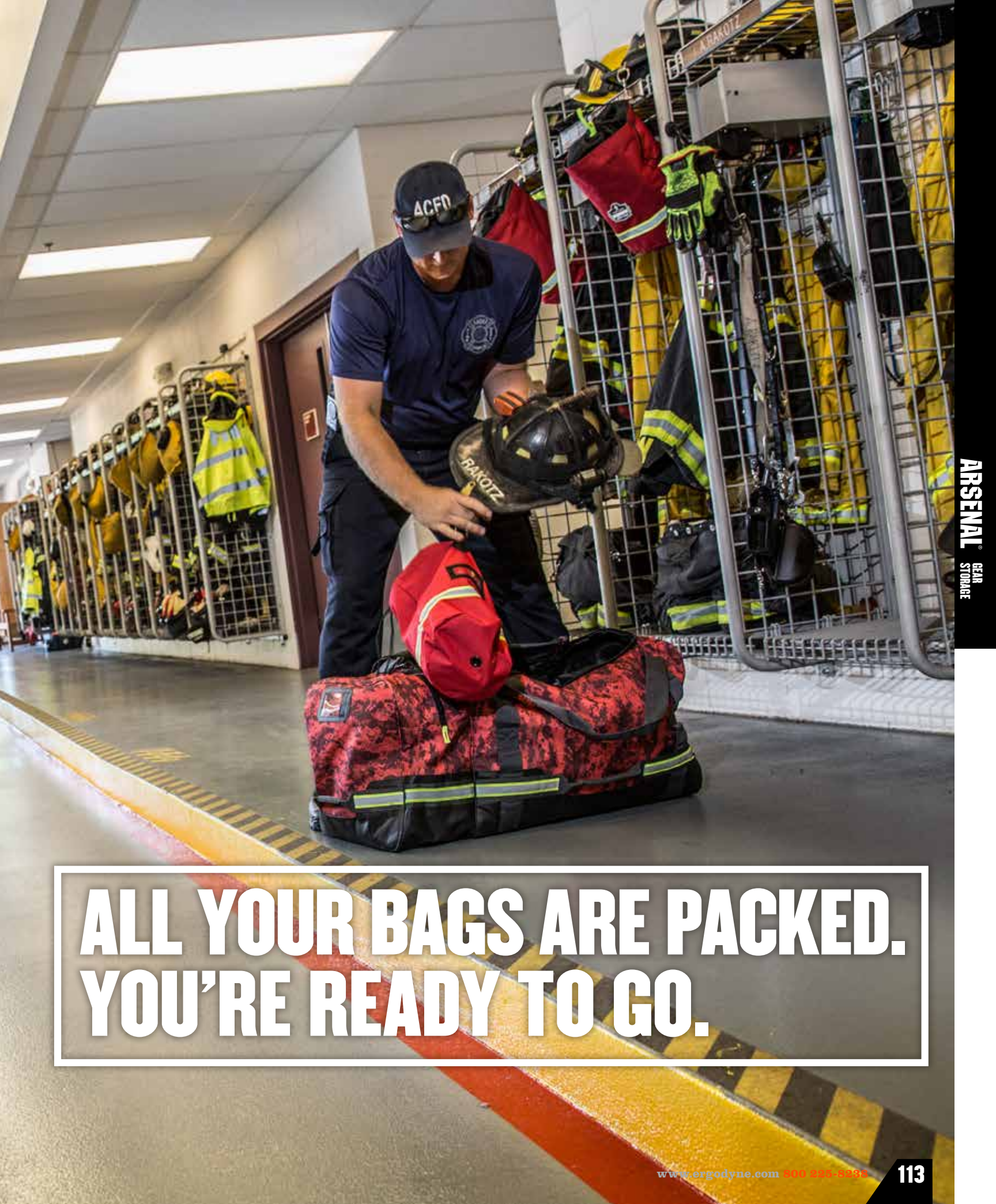

**ALL YOUR BAGS ARE PACKED.
YOU'RE READY TO GO.**



ARSENAL® GEAR STORAGE

This isn't your textbook line of storage. These packs, duffels, and buckets are designed, equipped, and tested for students and alumni of the school of hard knocks. Made of the toughest material, this line is designed to keep the gear you use to stay safe and productive — safe and productive. So whether you're hoisting, holding, or rolling, ask yourself, what's in your Arsenal®?

EQUIPMENT BAGS // PACKS & DUFFEL SERIES



5120 Large Wheeled Gear Bag



5125 Carry-On Luggage



5115 Small General Duty Bag



5116 Medium General Duty Bag

EQUIPMENT BAGS // PPE STORAGE SERIES



5193 AED Carrying Bag



5082 SCBA Mask Bag



5080 SCBA Mask Bag



5130 Fall Protection Bag

EQUIPMENT BAGS // PUBLIC SAFETY SERIES



5008 Equipment Gear Bag



5005 Large F&R Gear Bag



5005W Wheeled F&R Gear Bag



5063 Step-In Gear Bag

EQUIPMENT BAGS // PUBLIC SAFETY SERIES



5216 Responder Gear Bag



5215 Large Trauma Bag



5210 Small Trauma Bag



5220 Responder Trauma Bag

EQUIPMENT BAGS // HOIST BUCKET SERIES



5730 Leather Bottom Bucket



5650 Syn. Leather Bottom Bucket



5735 XL Leather Bottom Bucket



5732 Tall Leather Bottom Bucket



5143 General Duty Backpack



5144 Mobile Office Backpack



5030 Water-Resistant Duffel



5020P Polyester Duffel



5020 Nylon Duffel



5180 Half-Mask Respirator Bag



5181 Full-Mask Respirator Bag



5182 Half-Mask Respirator Bag



5183 Full-Mask Respirator Bag



5184 Mouthbit Respirator Bag



5060 Step-In Combo Gear Bag



5092 Quick Adjust Suspenders



5093 Quick Adjust Suspenders-Reflective



5244 Responder Backpack



5243 Responder Trauma Backpack



5220 Responder Trauma Bag



5743 Large Plastic Bottom Bucket



5763 Plastic Bottom Bucket



5734 Small Plastic Bottom Bucket



5738 Bucket Safety Top

ARSENAL® GEAR STORAGE:

PACKS & DUFFEL SERIES

DIFFERENTIATED BY DESIGN:

HEAVY DUTY ZIPPERS

Heavy duty zippers deliver superb performance and quality.

OPEN DESIGN

Open design for maximum storage capacity.

REINFORCED BASE

Lays down a firm foundation and delivers excellent wear and moisture protection for your gear.

HEAVY GAUGE STITCHING

Heavy gauge stitching provides extra reinforcement and strength around all zippers, pockets, and openings on the bag.

MATERIAL BACKING

Material backing provides water protection to keep your gear dry, comfortable, and ready to use.



5120



5120

ORDER MULTIPLE 1

GENERAL DUTY BAG - LARGE



- 600D polyester main material
- Padded and adjustable shoulder strap
- Molded wheels for safe and easy transport
- Molded retractable pull handle
- 32.5"L x 14"W x 12.5"H (83cm x 35cm x 32cm)

ITEM #	SIZE	COLOR
13120	5880ci (96 l)	Black



5125

ORDER MULTIPLE 1

CARRY-ON LUGGAGE



- 1680D ballistic polyester
- Molded retractable pull handle
- Rugged construction with extra bartacks and nylon
- Molded wheels for safe and easy transport
- 14"L x 9"W x 22.5"H (36cm x 23cm x 57cm)

ITEM #	SIZE	COLOR
13125	3790ci (62 l)	Black

SIZING UP YOUR ARSENAL®

How big is big? How many Gary Colemans can you fit in a large 5030? You have questions... we have answers. Speaking of making your life easier... we've standardized our sizing descriptions on our products. When an Ergodyne product is logo'd, we consider that the length facing, then the width is the depth of the product and lastly the height is just that... the overall height of the product. Easy as 123...cubic inches.



So to recap, we present our sizes as L x W x H. Learn it. Live it. Love it.

	5143	ORDER MULTIPLE 1
GENERAL DUTY BACKPACK		
<ul style="list-style-type: none"> • 600D polyester main material • Rucksack design for maximum storage • Top cover flap for protection from the elements • Padded computer sleeve in main pouch • 15"L x 8"W x 19"H (38cm x 20cm x 48cm) 		
ITEM #	SIZE	COLOR
13043	3600ci (59 l)	Black

	5144	ORDER MULTIPLE 1
MOBILE OFFICE BACKPACK		
<ul style="list-style-type: none"> • 1200D polyester material with PVC backing • Four main compartments, two vertical side pockets • Personal items pocket with headphones port • Cushioned back padding with airflow design • 14"L x 8"W x 20"H (36cm x 20cm x 51cm) 		
ITEM #	SIZE	COLOR
13044	2240ci (37 l)	Black

	5115/5116	ORDER MULTIPLE 1			
GENERAL DUTY BAG					
<ul style="list-style-type: none"> • 600D polyester main material • Heavy-duty PP webbing for structure and durability • Water repellent backing on main material • Padded and adjustable shoulder strap • 5116: 23.5"L x 9.5"W x 12"H (60cm x 24cm x 30cm) • 5115: 17.5"L x 8.5"W x 10"H (45cm x 22cm x 25cm) 					
ITEM #	SIZE	COLOR	ITEM #	SIZE	COLOR
13016	3780ci (62 l)	Black	13015	2220ci (36 l)	Black

	5030	ORDER MULTIPLE 1			
WATER RESISTANT DUFFEL BAG					
<ul style="list-style-type: none"> • Water-resistant tarpaulin w/ 1000D poly mesh • Shoulder straps carry as duffel or backpack • Four compression straps and two haul handles • Open design for maximum storage capacity • S: 23.5"L x 12"W x 11"H (60cm x 30cm x 28cm) • M: 27"L x 13.5"W x 12"H (69cm x 34cm x 30cm) • L: 30.5"L x 15"W x 15"H (77cm x 38cm x 38cm) 					
ITEM #	SIZE	COLOR	ITEM #	SIZE	COLOR
13030	4395ci (72 l)	Black	13034	9460ci (155 l)	Black
13032	5495ci (90 l)	Black			

	5020P	ORDER MULTIPLE 1			
POLYESTER DUFFEL BAG					
<ul style="list-style-type: none"> • 600D Polyester w/ PVC Backing • Heavy-duty ribbed straps on top and side • Heavy-duty #8 zippers • Removable shoulder strap and strap grabber • S: 23"L x 12"W x 12"H (58cm x 30cm x 30cm) • M: 28.5"L x 13"W x 13"H (73cm x 33cm x 33cm) • L: 35"L x 14"W x 14"H (89cm x 36cm x 36cm) 					
ITEM #	SIZE	COLOR	ITEM #	SIZE	COLOR
13320	2600 ci (44 l)	Black	13322	6300 ci (104 l)	Black
13321	3800 ci (63 l)	Black			

	5020	ORDER MULTIPLE 1			
NYLON DUFFEL BAG					
<ul style="list-style-type: none"> • 600D nylon body material • Heavy-duty ribbed straps on top and side • Heavy-duty #8 zippers • Removable shoulder strap and strap grabber • S: 23"L x 12"W x 12"H (58cm x 30cm x 30cm) • M: 28.5"L x 13"W x 13"H (73cm x 33cm x 33cm) • L: 35"L x 14"W x 14"H (89cm x 36cm x 36cm) 					
ITEM #	SIZE	COLOR	ITEM #	SIZE	COLOR
13020	2600ci (44 l)	Red	13022	6300ci (104 l)	Red
13021	3800ci (63 l)	Red			

ARSENAL® GEAR STORAGE:

PPE STORAGE SERIES

TOP CLOSURE

Top closure secures mask in the bag.

DIFFERENTIATED BY DESIGN:

OPEN DESIGN

Open design easily fits most standard half and full respirator masks.

HEAVY DUTY FABRICS

Heavy duty woven fabric is extremely abrasion resistant.



5082

5080/5080L			ORDER MULTIPLE 1
SCBA MASK BAG			
5080L			
<ul style="list-style-type: none"> • Spring loaded steel clasp attaches to gear or belt • Drawstring opening and barrel lock closure • Reflective Stripe • 5080L: Features brushed polyester fleece lining • 8.5"L x 8.5"W x 14"H (21cm x 21cm x 35cm) 			
5080:		5080L:	
ITEM #	SIZE	COLOR	
13080	650ci (11 l)	Red	
ITEM #	SIZE	COLOR	
13081	650ci (11 l)	Red	

		5082	ORDER MULTIPLE 1
SCBA MASK			
NEW FOR '16			
<ul style="list-style-type: none"> • 1000D nylon, double-coated polyurethane • One-handed drawstring/loop for quick access • Steel clasp attaches to gear, belt, or bag • Reflective stripe for visibility • Grommet at bottom for drainage and ventilation • 8.5"L x 8.5"W x 14"H (21cm x 21cm x 35cm) 			
ITEM #	SIZE	COLOR	
13082	650ci (11 l)	Red	

		5193	ORDER MULTIPLE 1
AED CARRYING BAG			
NEW FOR '16			
<ul style="list-style-type: none"> • 600D polyester main material • Removable shoulder strap with shoulder pad • Internal pocket for instructions • Steel clasp attaches to gear, bag, or anchor • 9"L x 5"W x 9.5"H (23cm x 13cm x 24cm) 			
ITEM #	SIZE	COLOR	
13193	427ci (7 l)	Blue	

	5180	ORDER MULTIPLE 1
HALF-MASK RESPIRATOR WAIST PACK		
<ul style="list-style-type: none"> • 420D nylon w/ PVC backing • Plastic buckle closure on waist strap • Cover flap with hook and loop closure • 7.5"L x 3.5"W x 6"H (19cm x 8cm x 15cm) 		
ITEM #	SIZE	COLOR
13180	135ci (2.2 l)	Black

	5181	ORDER MULTIPLE 1
FULL-FACE RESPIRATOR BAG		
<ul style="list-style-type: none"> • 420D nylon w/ PVC backing • Hook and loop allows for easy attachment • Cover flap with hook and loop closure • 10"L x 3.5"W x 6"H (25cm x 9cm x 15cm) 		
ITEM #	SIZE	COLOR
13181	190ci (3 l)	Black

	5182	ORDER MULTIPLE 1
HALF-MASK RESPIRATOR BAG		
<ul style="list-style-type: none"> • 420D nylon w/ PVC backing • Hook and loop allows for easy attachment • Cover flap with hook and loop closure • 8.5"L x 3"W x 7"H (22cm x 8cm x 18cm) 		
ITEM #	SIZE	COLOR
13182	145ci (2.4 l)	Black

	5183	ORDER MULTIPLE 1
FULL-MASK RESPIRATOR BAG		
<ul style="list-style-type: none"> • 420D nylon w/ PVC backing • Hook and loop allows for easy attachment • Cover flap with hook and loop closure • 9.5"L x 4"W x 12"H (24cm x 10cm x 30cm) 		
ITEM #	SIZE	COLOR
13183	300ci (5 l)	Black

	5184	ORDER MULTIPLE 1
MOUTHBIT RESPIRATOR WAIST PACK		
<ul style="list-style-type: none"> • 420D nylon w/ PVC backing • Plastic buckle closure on waist strap • Cover flap with hook and loop closure • 5"L x 4"W x 6.5"H (13cm x 10cm x 17cm) 		
ITEM #	SIZE	COLOR
13184	100ci (1.6 l)	Black

	5130	ORDER MULTIPLE 1
FALL PROTECTION BAG		
<ul style="list-style-type: none"> • 600D polyester w/ PVC backing • Drawstring opening and barrel lock closure • Webbing carry strap handle, grommets drain hole • Flap to protect from dust-filled environments • 10"L x 10"W x 15"H (26cm x 26cm x 38cm) 		
ITEM #	SIZE	COLOR
13130	1,100ci (18 l)	Black

* Note: respirators not included... Duh!

ARSENAL® GEAR STORAGE:

PUBLIC SAFETY SERIES

DIFFERENTIATED BY DESIGN:

HEAVY DUTY ZIPPERS

Industrial grade double-pull zippers with improved pull tabs mean reliability and performance over the long haul; double-pulls also allow secure locking.

SIZE

Arsenal® Fire and Equipment bags offer the size you need for all your turnout gear, tower gear, or whatever else you need to haul.

HEAVY DUTY FABRICS

Abrasion resistant woven fabrics with water resistant backing; some styles offer reinforced tarpaulin base fabric to take on the wear and tear you put it through.



LOGO READY

Maltese cross or other logo can be applied to any bag.

ADJUSTABLE PADDED SHOULDER STRAPS

All Arsenal® Fire and Equipment bags come with removable shoulder straps that adjust to your preferred length and include a shoulder pad for carrying.

5008



FIND OUT MORE ABOUT THE TECHNOLOGY THAT GOES INTO THE FULL LINE OF ERGODYNE GEAR STORAGE AT: WWW.ERGODYNE.COM

	5008	ORDER MULTIPLE 1
FIRE AND EQUIPMENT GEAR BAG		
  		
<ul style="list-style-type: none"> • 1000D polyester main material • Tarpaulin reinforced bottom with molded feet • 360 degree grab handles to move at any angle • Reflective stripping for visibility • 31"L x 16"W x 15.5"H (79cm x 41cm x 39cm) 		
ITEM #	SIZE	COLOR
13009	7688ci (126 l)	Black
13008	7688ci (126 l)	Red

	5005	ORDER MULTIPLE 1
LARGE F&R GEAR BAG		
 		
<ul style="list-style-type: none"> • 1000D nylon, double coated polyurethane • Heavy-duty #10 zippers • 2" webbing handle and shoulder straps • Grab'n go pull strap and removable shoulder strap • 30"L x 15"W x 15"H (76cm x 38cm x 38cm) 		
ITEM #	SIZE	COLOR
13005	7280ci (119 l)	Red

	5005_w	ORDER MULTIPLE 1
WHEELED F&R GEAR BAG		
 		
<ul style="list-style-type: none"> • 1000D nylon, double coated polyurethane • Heavy-duty #10 zippers • 2" webbing handle and shoulder straps • Grab'n go pull strap and removable shoulder strap • 31"L x 14"W x 14"H (79cm x 36cm x 36cm) 		
ITEM #	SIZE	COLOR
13205	7160ci (117 l)	Red

	5060	ORDER MULTIPLE 1
THREE-COMPARTMENT STEP-IN GEAR BAG		
 		
<ul style="list-style-type: none"> • 1000D nylon, double coated polyurethane • Removable shoulder strap and strap grabber • Heavy-duty #10 zippers • Maltese cross • 29"L x 15"W x 15"H (74cm x 38cm x 38cm) 		
ITEM #	SIZE	COLOR
13060	6750ci (111 l)	Red

	5063	ORDER MULTIPLE 1
CENTER OPENING STEP-IN GEAR BAG		
 		
<ul style="list-style-type: none"> • 1000D nylon, double coated polyurethane • 2" webbing handle and shoulder straps • Heavy-duty #10 zippers • Maltese cross • 20"L x 18"W x 15"H (51cm x 46cm x 38cm) 		
ITEM #	SIZE	COLOR
13063	5400ci (88 l)	Red

5092/5093	ORDER MULTIPLE 1				
PADDLED QUICK ADJUST SUSPENDERS					
 					
<ul style="list-style-type: none"> • 600D nylon body material • Heavy-duty polyester webbing • "H" back design • Foam padded shoulder straps • 5093: Features reflective stripes 					
5092:	5093: REFLECTIVE				
ITEM #	SIZE	COLOR	ITEM #	SIZE	COLOR
13339	30" (76cm)	Red	13349	30" (76cm)	Red
13340	36" (91cm)	Red	13350	36" (91cm)	Red
13341	42" (106cm)	Red	13351	42" (106cm)	Red
13342	48" (121cm)	Red	13352	48" (121cm)	Red

ARSENAL® GEAR STORAGE:

PUBLIC SAFETY SERIES

DIFFERENTIATED BY DESIGN:

HEAVY DUTY ZIPPERS

Industrial grade double-pull zippers with improved pull tabs mean reliability and performance over the long haul; double-pulls also allow secure locking.

WIDE MOUTH OPENINGS

Main compartments consist of wide access fold down openings making it easy for users to find and access equipment.



5216

INTERNAL DIVIDERS

Transitional internal dividers can be set up to the user's liking, compartmentalizing your responder equipment.

PALS WEBBING SLOTS

Interior and exterior slotted webbing for storage of tools you need when the time calls for it.

REFLECTIVE STRIPING

Hi-Vis reflective striping allows for better visibility.





FIND OUT MORE ABOUT THE TECHNOLOGY THAT GOES INTO THE FULL LINE OF ERGODYNE GEAR STORAGE AT: WWW.ERGODYNE.COM

  	5216	ORDER MULTIPLE 1
RESPONDER GEAR BAG		
 		
<ul style="list-style-type: none"> • 600D polyester main material • Tarpaulin reinforced bottom with molded feet • Clamshell side pockets drop down for easy access • Tarpaulin cover folds open for access • 21"L x 14"W x 9"H (53cm x 36cm x 23cm) 		
ITEM #	SIZE	COLOR
13447	2646ci (43 l)	Blue

  	5215	ORDER MULTIPLE 1
LARGE RESPONDER TRAUMA BAG		
		
<ul style="list-style-type: none"> • 600D polyester w/ PVC backing • Adjustable internal dividers • Reflective stripe • Blue or Orange • 19"L x 12"W x 8.5"H (48cm x 30cm x 22cm) 		
ITEM #	SIZE	COLOR
13437	1870ci (28 l)	Blue
13738	1870ci (28 l)	Orange

  	5210	ORDER MULTIPLE 1
SMALL RESPONDER TRAUMA BAG		
		
<ul style="list-style-type: none"> • 600D polyester w/ PVC backing • ID card window • Reflective stripe • Blue or Orange • 16.5"L x 10"W x 7"H (42cm x 25cm x 18cm) 		
ITEM #	SIZE	COLOR
13417	1020ci (15 l)	Blue
13718	1020ci (15 l)	Orange

  	5244	ORDER MULTIPLE 1
RESPONDER BACKPACK		
 		
<ul style="list-style-type: none"> • 600D polyester main material • Tarpaulin reinforced bottom with molded feet • Storage straps for pad, blanket, or other gear • Vented foam padding on back and shoulder straps • 14.5"L x 5"W x 20"H (37cm x 13cm x 51cm) 		
ITEM #	SIZE	COLOR
13497	1450ci (24 l)	Blue

  	5243	ORDER MULTIPLE 1
RESPONDER TRAUMA BACKPACK		
		
<ul style="list-style-type: none"> • 600D polyester w/ PVC backing • 3" padded shoulder straps w/ reflective striping • Phone holder • Heavy-duty carry handle • 12"L x 7"W x 17.5"H (31cm x 18cm x 44cm) 		
ITEM #	SIZE	COLOR
13487	1560ci (26 l)	Blue
13788	1560ci (26 l)	Orange

  	5220	ORDER MULTIPLE 1
RESPONDER TRAUMA BAG		
		
<ul style="list-style-type: none"> • 600D polyester w/ PVC backing • 6 division multi-tiered mesh interior pocket • ID card window • Blue or Orange • 16.5"L x 7.5"W x 10"H (42cm x 19cm x 25cm) 		
ITEM #	SIZE	COLOR
13457	1190ci (20 l)	Blue
13458	1190ci (20 l)	Orange

ARSENAL® GEAR STORAGE:

HOIST BUCKET SERIES

DIFFERENTIATED BY DESIGN:

THIRD-PARTY CERTIFIED TO A 4:1 SAFETY FACTOR

Haul your gear safely and confidently knowing it's third-party certified to a 4:1 safety factor.

HEAVY GAUGE STITCHING

Heavy gauge nylon stitching provides extra reinforcement and strength around all zipper, pockets, and openings on the bag.

PATENTED SAFETY TOP

Patented safety top closure buckles around handles of bucket to secure contents inside.

DURABLE FABRICS

Heavy duty woven fabric is extremely abrasion resistant.

5650T

REINFORCED BOTTOM

Lays down a firm foundation and delivers excellent wear and moisture protection for your tools.



* Note: lanyards and tools not included... Duh!

		5760	ORDER MULTIPLE 1
HEAVY-DUTY CANVAS			
<ul style="list-style-type: none"> • 20oz canvas • Leather reinforced base • Zinc-plated alloy steel D-ring on handle • Zinc-plated alloy steel d-rings built into handle • 12.5" diameter (32cm), 17" height (43cm) 			
WEB HANDLE W/D-RINGS		WEB D-RINGS W/TOP	
ITEM #	SIZE	COLOR	ITEM #
14460	Std.	White	14560
			Std. White
// PATENTED			

		5650	ORDER MULTIPLE 1
HEAVY-DUTY NYLON			
<ul style="list-style-type: none"> • 840D nylon main material • Leather reinforced base • Zinc-plated alloy steel d-ring on handle • High tensile strength web handle • 12.5" diameter (32cm), 17" height (43cm) 			
WEB HANDLE W/D-RINGS		WEB D-RINGS W/TOP	
ITEM #	SIZE	COLOR	ITEM #
14650	Std.	Black	14750
			Std. Black
// PATENTED			

		5730	ORDER MULTIPLE 1
LEATHER BOTTOM CANVAS			
<ul style="list-style-type: none"> • 20oz canvas • Leather reinforced base • Heavy-gauge nylon stitching • PP rope handle • 12.5" diameter (32cm), 17" height (43cm) 			
ROPE HANDLE		ROPE HANDLE W/TOP	
ITEM #	SIZE	COLOR	
14430	Std.	White	
ITEM #	SIZE	COLOR	
14530	Std.	White	
// PATENTED			

		5735	ORDER MULTIPLE 1
LEATHER BOTTOM CANVAS - XL			
<ul style="list-style-type: none"> • 20oz canvas • Leather reinforced base • Interior pocket for organization • PP rope handle • 16" diameter (41cm), 20" height (51cm) 			
ROPE HANDLE		ROPE HANDLE W/TOP	
ITEM #	SIZE	COLOR	
14435	XL	White	
ITEM #	SIZE	COLOR	
14535	XL	White	
// PATENTED			

		5732	ORDER MULTIPLE 1
TALL LEATHER BOTTOM CANVAS			
<ul style="list-style-type: none"> • 20oz canvas • Leather reinforced base • 2 interior pockets for organization • PP rope handle • 10" diameter (25cm), 28" height (71cm) 			
ROPE HANDLE		ROPE HANDLE W/TOP	
ITEM #	SIZE	COLOR	
14432	Tall	White	
ITEM #	SIZE	COLOR	
14532	Tall	White	
// PATENTED			

		5740	ORDER MULTIPLE 1
LEATHER BOTTOM CANVAS			
<ul style="list-style-type: none"> • 20oz canvas • Leather reinforced base • Nickel-plated swivel clip • PP rope handle • 12.5" diameter (32cm), 17" height (43cm) 			
SWIVEL SNAP		SWIVEL SNAP W/TOP	
ITEM #	SIZE	COLOR	
14440	Std.	White	
ITEM #	SIZE	COLOR	
14540	Std.	White	
// PATENTED			

		5745	ORDER MULTIPLE 1
LEATHER BOTTOM CANVAS - XL			
<ul style="list-style-type: none"> • 20oz canvas • Leather reinforced base • Nickel-plated swivel clip • PP rope handle • 16" diameter (41cm), 20" height (51cm) 			
SWIVEL SNAP		SWIVEL SNAP W/TOP	
ITEM #	SIZE	COLOR	
14445	XL	White	
ITEM #	SIZE	COLOR	
14545	XL	White	
// PATENTED			

		5742	ORDER MULTIPLE 1
TALL LEATHER BOTTOM CANVAS			
<ul style="list-style-type: none"> • 20oz canvas • Leather reinforced base • Nickel-plated swivel clip • PP rope handle • 10" diameter (25cm), 28" height (71cm) 			
SWIVEL SNAP		SWIVEL SNAP W/TOP	
ITEM #	SIZE	COLOR	
14442	Tall	White	
ITEM #	SIZE	COLOR	
14542	Tall	White	
// PATENTED			



5763

ORDER
MULTIPLE

1

HEAVY-DUTY CANVAS BUCKET





- 18oz canvas
- Molded plastic base
- Zinc-plated alloy steel D-ring on handle
- Interior pocket
- 12.5" diameter (32cm), 15" height (38cm)

WEB HANDLE W/D-RINGS			WEB W/D-RINGS & TOP		
ITEM #	SIZE	COLOR	ITEM #	SIZE	COLOR
14463	Std.	White	14563	Std.	White

// PATENTED



5733

ORDER
MULTIPLE

1

LARGE PLASTIC BOTTOM CANVAS BUCKET





- 18oz canvas
- Molded plastic base
- Heavy-gauge nylon stitching
- PP rope handle
- 12.5" diameter (32cm), 15" height (38cm)

ROPE HANDLE			ROPE HANDLE W/TOP		
ITEM #	SIZE	COLOR	ITEM #	SIZE	COLOR
14433	L	White	14533	L	White

// PATENTED



5734

ORDER
MULTIPLE

1

SMALL PLASTIC BOTTOM CANVAS BUCKET





- 18oz canvas
- Molded plastic base
- 2 interior pockets for organization
- PP rope handle
- 10" diameter (25cm), 14" height (36cm)

ROPE HANDLE			ROPE HANDLE W/TOP		
ITEM #	SIZE	COLOR	ITEM #	SIZE	COLOR
14434	S	White	14534	S	White

// PATENTED



5653

ORDER
MULTIPLE

1

HEAVY-DUTY NYLON BUCKET





- 840D nylon main material
- Molded plastic base
- Zinc-plated alloy steel d-ring on handle
- High tensile strength web handle
- 12.5" diameter (32cm), 17" height (43cm)

WEB HANDLE W/D-RINGS			WEB W/D-RINGS & TOP		
ITEM #	SIZE	COLOR	ITEM #	SIZE	COLOR
14653	Std.	Black	14753	Std.	Black

// PATENTED



5743

ORDER
MULTIPLE

1

LARGE PLASTIC BOTTOM CANVAS BUCKET





- 18oz canvas
- Molded plastic base
- Nickel-plated swivel clip
- PP rope handle
- 12.5" diameter (32cm), 15" height (38cm)

SWIVEL SNAP			SWIVEL SNAP W/TOP		
ITEM #	SIZE	COLOR	ITEM #	SIZE	COLOR
14443	L	White	14543	L	White

// PATENTED



5744

ORDER
MULTIPLE

1

SMALL PLASTIC BOTTOM CANVAS BUCKET





- 18oz canvas
- Molded plastic base
- Nickel-plated swivel clip
- PP rope handle
- 10" diameter (25cm), 14" height (36cm)

SWIVEL SNAP			SWIVEL SNAP W/TOP		
ITEM #	SIZE	COLOR	ITEM #	SIZE	COLOR
14444	S	White	14544	S	White

// PATENTED

5737

ORDER
MULTIPLE
1

X-LARGE BUCKET SAFETY TOP - CANVAS



- 18oz canvas
- Best in class YKK Buckles
- Heavy-gauge nylon stitching
- PP webbing reinforced

ITEM #	SIZE	COLOR
14437	16"D (41cm)	White

// PATENTED

5738

ORDER
MULTIPLE
1

LARGE BUCKET SAFETY TOP - CANVAS



- 18oz canvas
- Best in class YKK Buckles
- Heavy-gauge nylon stitching
- PP webbing reinforced

ITEM #	SIZE	COLOR
14438	12.5"D (32cm)	White

// PATENTED

5739

ORDER
MULTIPLE
1

SMALL BUCKET SAFETY TOP - CANVAS



- 18oz canvas
- Best in class YKK Buckles
- Heavy-gauge nylon stitching
- PP webbing reinforced

ITEM #	SIZE	COLOR
14439	10"D (25cm)	White

// PATENTED

5638

ORDER
MULTIPLE
1

LARGE BUCKET SAFETY TOP - NYLON



- 840D nylon main material
- Best in class YKK Buckles
- Heavy-gauge nylon stitching
- PP webbing reinforced

ITEM #	SIZE	COLOR
14638	12.5"D (32cm)	Black

// PATENTED

ARSENAL® HOIST BUCKET SELECT-O-MATIC Tables are good. They help us make sense of our lives. Scan the table below to select buckets by size, volume, weight capacity, and to match models with the correct bucket tops.

MODEL	DIAMETER (IN/CM)	HEIGHT (IN/CM)	GALLONS	LITERS	SWIVEL SNAP	INTERIOR POCKETS	MAX. WORK LBS.	MAX. WORK KG.	TOP MODEL #	MODEL # WITH TOP
5650	12.5 / 32	17 / 43	7.8	34.2	D-ring	1	150	68	5638	5650T
5653	12.5 / 32	15 / 38	6.8	30.2	D-ring	1	100	45	5638	5653T
5760	12.5 / 32	17 / 43	7.8	34.2	D-ring	1	150	68	5638	5760T
5763	12.5 / 32	15 / 38	6.8	30.2	D-ring	1	100	45	5638	5763T
5730	12.5 / 32	17 / 43	7.8	34.2	No	1	150	68	5738	5730T
5732	10 / 25	28 / 71	8.2	36.0	No	2	125	57	5739	5732T
5733	12.5 / 32	15 / 38	6.8	30.2	No	1	100	45	5738	5733T
5734	10 / 25	14 / 36	4.4	19.3	No	2	75	34	5739	5734T
5735	16 / 41	20 / 51	15.0	65.9	No	1	150	68	5737	5735T
5740	12.5 / 32	17 / 43	7.8	34.2	Yes	1	150	68	5738	5740T
5742	10 / 25	28 / 71	8.2	36.0	Yes	2	125	57	5739	5742T
5743	12.5 / 32	15 / 38	6.8	30.2	Yes	1	100	45	5738	5743T
5744	10 / 25	14 / 36	4.4	19.3	Yes	2	75	34	5739	5744T
5745	16 / 41	20 / 51	15.0	65.9	Yes	1	150	68	5737	5745T

Maximum working capacity is calculated by third party load testing to a safety factor of 4.



ARSENAL[®]
TOOL STORAGE



LOAD 'EM UP. LOAD 'EM OUT.

ARSENAL[®]
TOOL
STORAGE



ARSENAL® TOOL STORAGE

The rusted out box of bolts in your driveway gets you into trouble with the neighborhood association. The bucket of bolts rising up into the air towards the hardworking men and women who need them is a risk no one should take without our trusted Arsenal® Tool Storage in tow. Safely sending and storing all the knick knacks and paddy whacks of your current vocation wherever you may find yourself. Your cohorts on the ground thank you.

TOOL STORAGE // BELT & ACCESSORY SERIES



5550 3-inch Padded Work Belt



5555 5-inch Padded Work Belt



5560 Tool Belt Suspenders



5538 Topped Parts Pouch

TOOL STORAGE // BELT & ACCESSORY SERIES



5548 Electrician's Tool Pouch



5522 16-Pocket Tool Pouch



5532 11-Pocket Fastener Pouch



5567 Utility Knife Holder

TOOL STORAGE // BAG & ORGANIZER SERIES



5815 Large Open Face Tool Bag



5817 Medium Open Face Tool Bag



5808 Long Widemouth Tool Bag



5802 Medium Widemouth Tool Bag

TOOL STORAGE // BAG & ORGANIZER SERIES



5888 Cable Organizer



5870 Tool Roll-Up



5782 Wrench Roll-Up



5850 Buddies Tool Carrier



5528 Topped Parts Pouch



5518 Topped Tool Pouch



5516 Topped Tool Pouch



5725 Topped Bolt Bag



5728 Topped Bolt Bag



5700 16-Pocket Apron



5706 13-Pocket Waist Apron



5500 28-Pocket Synthetic Rig



5506S Installer Rig



5804 Small Widemouth Tool Bag



5843 Tool Backpack



5840 Electrician Tool Bag



5810 Open Top Tool Bag



5875/5876 Buddy Organizer



5920 Magnetic Tray Organizer



5925 Magnetic Tray Organizer

ARSENAL® TOOL STORAGE:

BELT & ACC. SERIES

DIFFERENTIATED BY DESIGN:

NICKEL PLATED HARDWARE

Nickel plated hardware is abrasion and corrosion resistant.

DURABLE FABRICS

Heavy duty woven and tarpaulin fabrics are extremely abrasion resistant.

NICKEL PLATED STORM DRAIN™

Patented Storm Drains™ keep tools and fasteners ventilated and dry; nickel plating is corrosion resistant to last over the long haul.



BELT LOOP ATTACHMENT

Belt loop on back of pouch easily attaches to worker's belts or fall protection harnesses, allowing for easy customization for worker's preference.

D-RINGS FOR TOOL LANYARD ATTACHMENT

D-rings on the interior and exterior for easy tool lanyard attachment for all at heights and FME/FOD applications.

5538

	5550	ORDER MULTIPLE 1
3" TOOL BELT		
<ul style="list-style-type: none"> • Thick, vented foam padding for comfort • Nickel-plated 2" double tongue metal roller buckle • Nickel-plated grommets set firmly for durability • Nickel-plated suspender anchors 		
ITEM #	SIZE	COLOR
13653	L	Black
13654	XL	Black
13655	2XL	Black

	5555	ORDER MULTIPLE 1
5" TOOL BELT		
<ul style="list-style-type: none"> • Thick, vented foam padding for comfort • Nickel-plated 2" double tongue metal roller buckle • Nickel-plated grommets set firmly for durability • Nickel-plated suspender anchors 		
ITEM #	SIZE	COLOR
13657	L	Black
13658	XL	Black
13659	2XL	Black

	5560	ORDER MULTIPLE 1
PADDED TOOL BELT SUSPENDERS		
<ul style="list-style-type: none"> • Thick, vented foam padding for comfort • Gel at key ride points for optimal comfort • Quick adjust suspender style • Nickel-plated, spring-loaded, pivoting clips • Cell phone holder 		
ITEM #	SIZE	COLOR
13665	—	Gray

		5528	ORDER MULTIPLE 1
TOPPED PARTS POUCH			
<ul style="list-style-type: none"> • 20oz water resistant canvas • Trap door closure for safety and security • 2 exterior tool loops • 2 exterior nickel-plated D-rings for tool lanyard • 7.5"L x 7.5"W x 12"H (19cm x 19cm x 30cm) 			
ITEM #	SIZE	COLOR	
13628	—	Black	

		5516	ORDER MULTIPLE 1
TOPPED TOOL POUCH - STRAP DESIGN			
<ul style="list-style-type: none"> • 16 pockets for tools and fasteners • Top cover flap with buckle closure • Three nickel-plated D-rings • Strap designed for quick attachment and removal • 11"L x 4.5"W x 11"H (28cm x 11cm x 28cm) 			
ITEM #	SIZE	COLOR	
13640	—	Gray	

		5518	ORDER MULTIPLE 1
TOPPED TOOL POUCH - LOOP DESIGN			
<ul style="list-style-type: none"> • 19 pockets for tools and fasteners • Top cover flap with hook and loop closure • Three nickel-plated D-rings • Belt loop on back attaches to tool belts • 11"L x 4.5"W x 11"H (28cm x 11cm x 28cm) 			
ITEM #	SIZE	COLOR	
13642	—	Gray	

		5538	ORDER MULTIPLE 1
TOPPED PARTS POUCH			
<ul style="list-style-type: none"> • Waterproof tarpaulin material • Trap door closure for safety and security • 2 exterior tool loops • 2 exterior D-rings for tool lanyard attachment • 7.5"L x 7.5"W x 12"H (19cm x 19cm x 30cm) 			
ITEM #	SIZE	COLOR	
13638	—	Orange	

		5725	ORDER MULTIPLE 1
TOPPED BOLT BAG			
<ul style="list-style-type: none"> • 16oz canvas • One-handed closure for safety • Nickel-plated rivets • 2 exterior tool loops • 10"L x 5"W x 9"H (25cm x 13cm x 23cm) 			
ITEM #	SIZE	COLOR	
14425	—	White	

		5728	ORDER MULTIPLE 1
TOPPED BOLT BAG			
<ul style="list-style-type: none"> • 16oz canvas • One-handed closure for safety • Nickel-plated rivets • 2 exterior tool loops • 10"L x 5"W x 13"H (25cm x 13cm x 33cm) 			
ITEM #	SIZE	COLOR	
14428	—	White	



5548

ORDER
MULTIPLE
1

ELECTRICIANS' TOOL POUCH



- 2 large main pockets
- 5 smaller pockets
- 6 large screwdriver slots
- Electrical tape chain and tool spring clip
- 9.5"L x 3.5"W x 12.5"H (33cm x 6cm x 32cm)

ITEM #	SIZE	COLOR
13648	—	Gray



5522

ORDER
MULTIPLE
1

FRAMER/BUILDER TOOL POUCH



- 4 main pockets for fasteners and tools
- 12 smaller pockets and tool holders
- Nickel-plated hardware and angled hammer loop
- Detachable tape measure pocket
- 11"L x 5.5"W x 14"H (28cm x 14cm x 36cm)

ITEM #	SIZE	COLOR
13622	—	Gray



5532

ORDER
MULTIPLE
1

FRAMER/BUILDER FASTENER POUCH



- 4 main pockets for fasteners and tools
- 7 smaller pockets and tool holders
- Nickel-plated hardware and tape measure clip
- Diamond PVC bases with Storm Drains™
- 10"L x 4"W x 14"H (25cm x 10cm x 35cm)

ITEM #	SIZE	COLOR
13632	—	Gray



5567

ORDER
MULTIPLE
1

UTILITY KNIFE HOLDER



- Fits most utility knife designs
- PE-reinforced opening
- Stainless steel belt clip
- Two exterior pen/marker slots
- 2"L x 1"W x 9"H (5cm x 3cm x 23cm)

ITEM #	SIZE	COLOR
13667	—	Gray



5700

ORDER
MULTIPLE
1

16-POCKET APRON



- 14oz 100% cotton duck with reflective trim
- 16-pocket apron features 3-compartment pocket
- 5 pockets for larger tools & cell phone
- 8 pockets for pens, pencils, and small tools
- Dual hammer loops

ITEM #	SIZE	COLOR
13690	—	Gray



5706

ORDER
MULTIPLE
1

13-POCKET APRON



- 14oz 100% cotton duck with reflective trim
- 13-pocket waist apron
- 5 pockets for larger tools & cell phone
- 8 pockets for pens, pencils, and small tools
- Dual hammer loops

ITEM #	SIZE	COLOR
13695	—	Gray

<p>FRAMER/BUILDER TOOL BELT</p>		<p>5500</p>	<p>ORDER MULTIPLE 1</p>									
<div style="display: flex; justify-content: space-between;"> <div style="width: 45%;">  <p>* Note: tools and supplies not included... Duh!</p> </div> <div style="width: 50%;"> <ul style="list-style-type: none"> • 5" padded base layer tool belt (5555) • 16-pocket tool pouch (5522) • Padded suspenders - sold separately (5560) • 11 pocket fastener pouch (5532) • Nickel-plated hammer holder <table border="1" data-bbox="1177 598 1390 667"> <thead> <tr> <th>ITEM #</th> <th>SIZE</th> <th>COLOR</th> </tr> </thead> <tbody> <tr> <td>13601</td> <td>L</td> <td>Gray</td> </tr> <tr> <td>13602</td> <td>XL</td> <td>Gray</td> </tr> </tbody> </table> </div> </div>				ITEM #	SIZE	COLOR	13601	L	Gray	13602	XL	Gray
ITEM #	SIZE	COLOR										
13601	L	Gray										
13602	XL	Gray										

<p>FRAMER/BUILDER TOOL BELT</p>		<p>5504</p>	<p>ORDER MULTIPLE 1</p>									
<div style="display: flex; justify-content: space-between;"> <div style="width: 45%;">  <p>* Note: tools and supplies not included... Duh!</p> </div> <div style="width: 50%;"> <ul style="list-style-type: none"> • 5" padded base layer tool belt (5555) • Abrasion-resistant PVC reinforced pouch bases • Padded suspenders - sold separately (5560) • Tape holder - large (5571) • Nickel-plated hammer holder <table border="1" data-bbox="1177 1150 1390 1220"> <thead> <tr> <th>ITEM #</th> <th>SIZE</th> <th>COLOR</th> </tr> </thead> <tbody> <tr> <td>13615</td> <td>L</td> <td>Gray</td> </tr> <tr> <td>13616</td> <td>XL</td> <td>Gray</td> </tr> </tbody> </table> </div> </div>				ITEM #	SIZE	COLOR	13615	L	Gray	13616	XL	Gray
ITEM #	SIZE	COLOR										
13615	L	Gray										
13616	XL	Gray										

<p>INSTALLER/DRILL HOLDER TOOL RIG WITH SUSPENDERS</p>		<p>5506_s</p>	<p>ORDER MULTIPLE 1</p>									
<div style="display: flex; justify-content: space-between;"> <div style="width: 45%;">  <p>* Note: tools and supplies not included... Duh!</p> </div> <div style="width: 50%;"> <ul style="list-style-type: none"> • 5" padded base layer tool belt (5555) • Aerial tool pouch with safety top (5518) • Reinforced bindings, semi-rigid • Ambidextrous drill holder pouch • Padded quick-adjust suspenders included <table border="1" data-bbox="1177 1703 1390 1772"> <thead> <tr> <th>ITEM #</th> <th>SIZE</th> <th>COLOR</th> </tr> </thead> <tbody> <tr> <td>13612</td> <td>L</td> <td>Gray</td> </tr> <tr> <td>13613</td> <td>XL</td> <td>Gray</td> </tr> </tbody> </table> </div> </div>				ITEM #	SIZE	COLOR	13612	L	Gray	13613	XL	Gray
ITEM #	SIZE	COLOR										
13612	L	Gray										
13613	XL	Gray										



FIND OUT MORE ABOUT THE TECHNOLOGY THAT GOES INTO THE FULL LINE OF ERGODYNE TOOL STORAGE AT: WWW.ERGODYNE.COM

ARSENAL® TOOL STORAGE:

BAG & ORGANIZER SERIES

DIFFERENTIATED BY DESIGN:

HEAVY DUTY ZIPPERS

Heavy duty zippers deliver superb performance and quality.

DURABLE FABRICS

Heavy duty woven fabric is extremely abrasion resistant.



5843

REINFORCED BASE

Lays down a firm foundation and delivers excellent wear and moisture protection for your tools.

VARIETY OF POCKETS

A large variety of pockets and slots accommodate a wide variety of tools for all kinds of workers.

D-RINGS FOR ATTACHMENT OF TOOL LANYARD

D-rings on the interior and exterior for easy tool lanyard attachment for all at heights and FME/FOD applications.



5815

ORDER MULTIPLE
1

OPEN FACE TOOL ORGANIZER - LARGE



- 61 pockets: ultimate in tool organization
- Molded rubber base
- Detachable phone holder and parts organizer
- Nickel-plated hardware
- 18"L x 11"W x 15"H (46cm x 28cm x 38cm)

ITEM #	SIZE	COLOR
13715	L	Gray



5817

ORDER MULTIPLE
1

OPEN FACE TOOL ORGANIZER - MEDIUM



- 44 pockets: ultimate in tool organization
- Molded rubber base
- Detachable phone holder and parts organizer
- Nickel-plated hardware
- 15"L x 8.5"W x 13.5"H (38cm x 22cm x 34cm)

ITEM #	SIZE	COLOR
13717	M	Gray

	5808	ORDER MULTIPLE 1
WIDEMOUTH TOOL ORGANIZER - LONG		
<ul style="list-style-type: none"> • 28 pockets: 12 exterior, 16 interior • Molded rubber base • Detachable phone holder and parts organizer • Nickel-plated hardware • 24"L x 10"W x 13"H (61cm x 25cm x 33cm) 		
ITEM #	SIZE	COLOR
13708	L	Gray

	5802	ORDER MULTIPLE 1
WIDEMOUTH TOOL ORGANIZER - MEDIUM		
<ul style="list-style-type: none"> • 28 pockets: 14 exterior, 14 interior • Molded rubber base • Detachable phone holder and parts organizer • Nickel-plated hardware • 14.5"L x 8.5"W x 11"H (37cm x 22cm x 28cm) 		
ITEM #	SIZE	COLOR
13702	M	Gray

	5804	ORDER MULTIPLE 1
WIDEMOUTH TOOL ORGANIZER - SMALL		
<ul style="list-style-type: none"> • 27 pockets: 10 exterior, 17 interior • Molded rubber base • Detachable phone holder and parts organizer • Nickel-plated hardware • 13.5"L x 7.5"W x 11"H (34cm x 19cm x 28cm) 		
ITEM #	SIZE	COLOR
13704	S	Gray

	5843	ORDER MULTIPLE 1
TOOL BACKPACK		
<ul style="list-style-type: none"> • 26 interior pockets and 7 exterior pockets • Tall tool holster on side panel • Padded shoulder straps for increased comfort • Reinforced comfort padding on the back • 13.5"L x 8.5"W x 18"H (34cm x 22cm x 61cm) 		
ITEM #	SIZE	COLOR
13743	—	Black

	5840	ORDER MULTIPLE 1
ELECTRICIANS TOOL ORGANIZER		
<ul style="list-style-type: none"> • 48 pockets and holders • 4 molded ABS plastic bases • Bio-curved padded shoulder strap and carry handle • Nickel-plated hardware • 11"L x 9"W x 9"W (28cm x 23cm x 23cm) 		
ITEM #	SIZE	COLOR
13740	—	Gray

	5810	ORDER MULTIPLE 1
OPEN TOP TOOL ORGANIZER		
<ul style="list-style-type: none"> • 30 pockets: 21 exterior, 9 interior • Molded rubber base • Outside tape loop • Nickel-plated hardware • 13"L x 7"W x 9.5"H (33cm x 18cm x 24cm) 		
ITEM #	SIZE	COLOR
13710	—	Gray



ARSENAL TOOL STORAGE

		5888	ORDER MULTIPLE 1
<p>CABLE ORGANIZER</p> 			
<ul style="list-style-type: none"> • 1680D ballistic polyester • Keeps jumper cables or cords stowed • Exterior pocket for maps, gauges, etc. • Rugged dual webbing handles • 13.5"L x 3.5"H (34cm x 9cm) 			
ITEM #	SIZE	COLOR	
13788	—	Gray	

		5870	ORDER MULTIPLE 1
<p>TOLL ROLL-UP</p> 			
<ul style="list-style-type: none"> • 25 pockets for various tools • Socket pockets holds 3/8" or 1/4" sockets • Carry handle for easy transport • Buckle closure • 27"L x 14.5"H (69cm x 37cm) 			
ITEM #	SIZE	COLOR	
13770	—	Gray	

		5872	ORDER MULTIPLE 1
<p>WRENCH ROLL-UP</p> 			
<ul style="list-style-type: none"> • 14 graduated tool slots fit most wrench sets • Fold, roll, and tie for easy transport • Fits 3/8"-1 1/4" or 6mm-32mm wrenches • Nickel-plated grommets for hanging • 26"L x 22"H (67cm x 56cm) 			
ITEM #	SIZE	COLOR	
13772	—	Gray	

		5780	ORDER MULTIPLE 1
<p>CANVAS TOLL ROLL-UP</p> 			
<ul style="list-style-type: none"> • 16oz canvas • 16 interior pockets • Carry handle for easy transport • Socket pockets holds 3/8" or 1/4" sockets • 22"L x 14.5"H (56cm x 37cm) 			
ITEM #	SIZE	COLOR	
14480	—	White	

		5782	ORDER MULTIPLE 1
<p>CANVAS WRENCH ROLL-UP</p> 			
<ul style="list-style-type: none"> • 16oz canvas • 14 graduated tool slots fit most wrench sets • Nickel-plated grommets for hanging • Heavy-gauge nylon stitching • 26.5"L x 16.5"W (67.5cm x 42cm) 			
ITEM #	SIZE	COLOR	
14482	—	White	

• Note: tools and supplies not included... Duh!

	5850	ORDER MULTIPLE 1
<p>BUDDIES CARRIER</p>		
<ul style="list-style-type: none"> • 25 interior pockets • Heavy-duty YKK zippers • ID pocket for business cards or labels • Comfortable carry handle and shoulder strap • 16"L x 7.5"W x 10"H (41cm x 19cm x 26cm) 		
ITEM #	SIZE	COLOR
13750	—	Black

	5850 _K	ORDER MULTIPLE 1
<p>BUDDY SYSTEM</p>		
<ul style="list-style-type: none"> • Two 5875 large buddies (blue and yellow) • Two 5876 small buddies (green and red) • Kitted together for one complete system • Comfortable carry handle and shoulder strap • 16"L x 7.5"W x 10"H (41cm x 19cm x 26cm) 		
ITEM #	SIZE	COLOR
13850	—	Black

	5920	ORDER MULTIPLE 1
<p>MAGNETIC TRAY ORGANIZER - RECTANGLE</p>		
<ul style="list-style-type: none"> • Corrosion resistant, durable stainless steel #430 • Trays keep small ferromagnetic components • Magnetic base for attachment • 5.5" x 9.5" x 1.1" (14cm x 24cm x 3cm) 		
ITEM #	SIZE	COLOR
14920	Rectangle	Stainless

	5875	ORDER MULTIPLE 1			
<p>BUDDIES ORGANIZER - LARGE</p>					
<ul style="list-style-type: none"> • Clamshell two pocket open design • Screened mesh material for visibility • ID pocket for business cards or labels • Color coded for easily distinguishing contents • 10"L x 4.5"W x 3.5"H (25cm x 12cm x 9cm) 					
ITEM #	SIZE	COLOR	ITEM #	SIZE	COLOR
13210	L	Black	13214	L	Green
13212	L	Blue	13215	L	Yellow
13213	L	Red	13875	L	4-Piece Kit

	5876	ORDER MULTIPLE 1			
<p>BUDDIES ORGANIZER - SMALL</p>					
<ul style="list-style-type: none"> • Clamshell two pocket open design • Screened mesh material for visibility • ID pocket for business cards or labels • Color coded for easily distinguishing contents • 7.5"L x 4.5"W x 3"H (19cm x 12cm x 8cm) 					
ITEM #	SIZE	COLOR	ITEM #	SIZE	COLOR
13220	S	Black	13224	S	Green
13222	S	Blue	13225	S	Yellow
13223	S	Red	13876	S	4-Piece Kit

	5925	ORDER MULTIPLE 1
<p>MAGNETIC TRAY ORGANIZER - ROUND</p>		
<ul style="list-style-type: none"> • Corrosion resistant, durable stainless steel #430 • Trays keep small ferromagnetic components • Magnetic base for attachment • Diameter 6", Depth 1.1" (14cm x 3cm) 		
ITEM #	SIZE	COLOR
14925	Round	Stainless

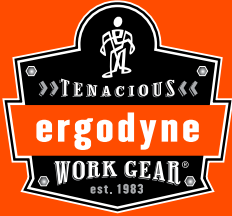

ELEMENT



TENTS



Chill-Its®

- » COOLING PRODUCTS
- » HYDRATION

SHAX®

PORTABLE WORK SHELTERS

- » POP-UP TENTS
- » UMBRELLAS
- » ACCESSORIES

N-FERNO®

- » WARMING PRODUCTS
- » ACCESSORIES

TREX™

- » ICE TRACTION DEVICES

CORE™

PERFORMANCE WORK WEAR

- » FR CLOTHING



**KEEP YOUR COOL WHEN THE
WORLD GOES VOLCANIC.**

**CHILL-ITS[®]
COOLING PRODUCTS**





CHILL-ITS® COOLING PRODUCTS

Some like it hot and some sweat when the heat is on. Find yourself on the latter camp no more with Chill-Its® Cooling Products. These babies aren't just a speed bump on the Highway to Hell, either. They're designed to give Heat Related Illness the cold shoulder and keep your mercury levels just the way you want them. Vests, bandanas, hydration vests, if it cools you down, we're ready to order it up.

COOLING PRODUCTS // EVAPORATIVE SERIES



6700MF Tie Bandana w/ Microfiber



6705MF H&L Bandana w/ Microfiber



6710MF Triangle Hat w/ Microfiber



6602MF Microfiber Towel

COOLING PRODUCTS // EVAPORATIVE SERIES



6717CT Neck Shade w/ Towel



8935CT Ranger Hat w/ Towel



6602 Cooling Towel



6603 Cooling Towel Band

COOLING PRODUCTS // EVAPORATIVE SERIES



6717 Hard Hat Neck Shade w/ Polymers



6700FR Tie Bandana w/ Polymers



6705FR H&L Bandana w/ Polymers



6710FR Triangle Hat w/ Polymers

COOLING PRODUCTS // ABSORPTIVE SERIES



6650 Hat w/ Neck Shade



6615 High-Performance Dew Rag



6630 High-Performance Skull Cap



6605 High-Performance Headband

COOLING PRODUCTS // PHASE CHANGE SERIES



6215 Premium Cooling Vest



6215HV Hi-Vis Premium Cooling Vest



6230 Standard Cooling Vest



6240 Vest Extender Kit



8935MF Ranger Hat w/ Microfiber



6705CT H&L Bandana w/Towel



6710CT Triangle Hat w/ Towel



6715CT Hard Hat Pad w/ Towel



6670CT Neck Shade w/ Towel



6700CT Tie Bandana w/ Towel



6700 Tie Bandana w/ Polymers



6705 H&L Bandana w/ Polymers



6710 Triangle Hat w/ Polymers



6715/6716 Hard Hat w/ Polymers



6717FR HH Neck Shade w/ Polymers



6685 Dry Evaporative Vest



6665 Wet Evaporative Vest



6660 Hard Hat Brim w/ Shade



6500/6550 Terry Elastic Band

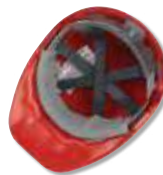

6609 Hard Hat Terry Sweatband



6485 Multi-band



6486 Flame Resistant Multi-band



5156 Premium Low-Profile



5157 Premium Cargo Hydration



5155HV Hi-Vis Low-Profile Hydration



5581 Modular Hydration Pack

COOLING PRODUCTS
// HYDRATION SERIES

CHILL-ITS® COOLING:

THE ANATOMY OF CHILL FACTOR X.

COOLING TECHNOLOGY

Using absorbent acrylic polymers, hyper-evaporative PVA, or microfiber material - these products activate easily and quickly to provide a cooling sensation.

SUN PROTECTION

Several Chill-Its® products provide a barrier between the worker and harmful UV rays.

CONSTRUCTION

Absorbent materials provide super-evaporative cooling for hours by wicking moisture away from the body.



FIND OUT MORE ABOUT THE TECHNOLOGY THAT
GOES INTO THE FULL LINE OF ERGODYNE COOLING
PRODUCTS AT: WWW.ERGODYNE.COM

THREE DIFFERENT TECHNOLOGIES. ONE PURPOSE: KOOLIN' THE GANG.

Heat and humidity sap worker productivity. Which is why the Evaporative Series works harder than a sled dog to provide up to 4 hours of consistent cooling relief. The secret? Three different hi-tech cooling technologies: a hyper-evaporative fabric, space age polymer cooling crystals and an advanced PVA material that holds water without feeling heavy. Let's face it, if there was a globally recognized Bandana Towel Technology University, Chill-Its® would have graduated Magna Cool Laude with honors.



SWEET COOLING RELIEF FOR YOUR INNER GREENIE.



MICROFIBER COOLING TOWEL:

Our new chemical free, non-toxic, cooling powerhouse. Microfiber technology activates instantly when wet, whether that be water or perspiration, and wicks moisture away from the body. Soft and absorbent when dry, and when wet provides sustained cooling for hours on end.



CALL IT COOL. JUST DON'T CALL IT A CHAMOIS.



PVA COOLING TOWEL (CT):

A hyper-evaporative material that's the latest in cooling innovation, this Poly Vinyl Acetal (PVA) material retains water while remaining dry to the touch to provide sweet cooling relief on those sweltering days. Flat earth society approved.



NON-ACTIVATED STATE



ACTIVATED STATE
PLUMPED UP AND READY TO WORK.

THEY PLUMP WHEN YOU CHILL 'EM!



ACRYLIC POLYMER CRYSTALS:

When soaked in cold water, these non-toxic, super-absorbent acrylic polymers expand and absorb just enough water to create a love potion #9 sensation for up to 4 hours. If sweet cooling sensation lasts more than four hours, please consult a physician☺.

CHILL-ITS® COOLING:

EVAPORATIVE SERIES

DIFFERENTIATED BY DESIGN:

COOLING TECHNOLOGY

Non-toxic, chemical free material is super evaporative and feels significantly cooler than ambient air when activated.

MICROFIBER CONSTRUCTION

Woven material is lightweight, soft and absorbent to provide all day comfort.

SUN PROTECTION

UPF 50 provides protection from the sun's harmful UV rays.



6602MF

COOLING TOWEL COLORS: *Note: all colors not necessarily available in all styles. See specific product for listing.



6700_{MF}

ORDER MULTIPLE
6

TIE BANDANA W/ MICROFIBER

NEW FOR '16



- Microfiber material is soft and absorbent
- Super-evaporative, feels cooler than ambient air
- Re-usable, just rewet to reactivate
- UPF 50 for protection against harmful UV rays
- Tie closure
- 2-sided color

ITEM #	SIZE	COLOR
12347	—	Blue

6705_{MF}

ORDER MULTIPLE
6

HOOK & LOOP BANDANA W/ MICROFIBER

NEW FOR '16



- Microfiber material is soft and absorbent
- Super-evaporative, feels cooler than ambient air
- Re-usable, just rewet to reactivate
- UPF 50 for protection against harmful UV rays
- Breakaway hook and loop closure
- 2-sided color

ITEM #	SIZE	COLOR
12357	—	Blue

6710_{MF}

ORDER MULTIPLE
6

TRIANGLE HAT W/ MICROFIBER

NEW FOR '16



- Microfiber material is soft and absorbent
- Super-evaporative, feels cooler than ambient air
- Re-usable, just rewet to reactivate
- UPF 50 for protection against harmful UV rays
- Tie closure
- 2-sided color

ITEM #	SIZE	COLOR
12367	—	Blue

6602_{MF}

ORDER MULTIPLE
6

MICROFIBER COOLING TOWEL



- Microfiber material is soft and absorbent
- Super-evaporative, feels cooler than ambient air
- Size: 9.8" x 40.9" (25cm x 104cm)
- UPF 50 for protection against harmful UV rays
- 2-sided color, gray on reverse for all colors

ITEM #	SIZE	COLOR	ITEM #	SIZE	COLOR
12660	—	Blue	12661	—	Orange
12662	—	Pink	12668	—	Gray
12669	—	HV Lime			

8935_{MF}

ORDER MULTIPLE
6

HI-VIS RANGER HAT W/ MICROFIBER

NEW FOR '16



- Microfiber material lines the inside hat rim
- Super-evaporative, feels cooler than ambient air
- Easily activated by running microfiber under water
- ANSI certified 150D oxford polyester
- Level 2 ANSI-compliant tape with contrasting color

ITEM #	SIZE	COLOR
12593	S/M	HV Lime
12595	L/XL	HV Lime

CHILL-ITS® COOLING:

EVAPORATIVE SERIES

DIFFERENTIATED BY DESIGN:

COOLING TECHNOLOGY

Using absorbent acrylic polymers, hyper-evaporative PVA, or micro-fiber material - these products activate easily and quickly to provide a cooling sensation.



			6705 CT			ORDER MULTIPLE 6																																
HOOK & LOOP COOLING BANDANA WITH TOWEL																																						
<ul style="list-style-type: none"> • Advanced PVA material activates easily and quickly • Re-usable, just re-wet • Super-evaporative cooling process keeps you cool • Breakaway hook and loop closure • Rinse before use 																																						
<table border="1"> <thead> <tr> <th>ITEM #</th> <th>SIZE</th> <th>COLOR</th> </tr> </thead> <tbody> <tr> <td>12571</td> <td>—</td> <td>Stars & Stripes</td> </tr> <tr> <td>12573</td> <td>—</td> <td>Red Western</td> </tr> <tr> <td>12574</td> <td>—</td> <td>Navy Western</td> </tr> <tr> <td>12576</td> <td>—</td> <td>HV Lime</td> </tr> </tbody> </table>			ITEM #	SIZE	COLOR	12571	—	Stars & Stripes	12573	—	Red Western	12574	—	Navy Western	12576	—	HV Lime	<table border="1"> <thead> <tr> <th>ITEM #</th> <th>SIZE</th> <th>COLOR</th> </tr> </thead> <tbody> <tr> <td>12577</td> <td>—</td> <td>Solid Blue</td> </tr> <tr> <td>12572</td> <td>—</td> <td>Camo</td> </tr> <tr> <td>12578</td> <td>—</td> <td>Flames</td> </tr> <tr> <td>12579</td> <td>—</td> <td>Skulls</td> </tr> </tbody> </table>			ITEM #	SIZE	COLOR	12577	—	Solid Blue	12572	—	Camo	12578	—	Flames	12579	—	Skulls	// PATENTED		
ITEM #	SIZE	COLOR																																				
12571	—	Stars & Stripes																																				
12573	—	Red Western																																				
12574	—	Navy Western																																				
12576	—	HV Lime																																				
ITEM #	SIZE	COLOR																																				
12577	—	Solid Blue																																				
12572	—	Camo																																				
12578	—	Flames																																				
12579	—	Skulls																																				

			6710 CT			ORDER MULTIPLE 6																																
COOLING TRIANGLE HAT WITH TOWEL																																						
<ul style="list-style-type: none"> • Advanced PVA material activates easily and quickly • Re-usable: just soak in water to re-activate • Super-evaporative cooling process keeps you cool • Tie closure • Rinse before use 																																						
<table border="1"> <thead> <tr> <th>ITEM #</th> <th>SIZE</th> <th>COLOR</th> </tr> </thead> <tbody> <tr> <td>12581</td> <td>—</td> <td>Stars & Stripes</td> </tr> <tr> <td>12583</td> <td>—</td> <td>Red Western</td> </tr> <tr> <td>12584</td> <td>—</td> <td>Navy Western</td> </tr> <tr> <td>12586</td> <td>—</td> <td>HV Lime</td> </tr> </tbody> </table>			ITEM #	SIZE	COLOR	12581	—	Stars & Stripes	12583	—	Red Western	12584	—	Navy Western	12586	—	HV Lime	<table border="1"> <thead> <tr> <th>ITEM #</th> <th>SIZE</th> <th>COLOR</th> </tr> </thead> <tbody> <tr> <td>12587</td> <td>—</td> <td>Solid Blue</td> </tr> <tr> <td>12582</td> <td>—</td> <td>Camo</td> </tr> <tr> <td>12588</td> <td>—</td> <td>Flames</td> </tr> <tr> <td>12589</td> <td>—</td> <td>Skulls</td> </tr> </tbody> </table>			ITEM #	SIZE	COLOR	12587	—	Solid Blue	12582	—	Camo	12588	—	Flames	12589	—	Skulls	// PATENTED		
ITEM #	SIZE	COLOR																																				
12581	—	Stars & Stripes																																				
12583	—	Red Western																																				
12584	—	Navy Western																																				
12586	—	HV Lime																																				
ITEM #	SIZE	COLOR																																				
12587	—	Solid Blue																																				
12582	—	Camo																																				
12588	—	Flames																																				
12589	—	Skulls																																				

			6715 CT			ORDER MULTIPLE 6								
COOLING TOWEL HARD HAT PAD														
<ul style="list-style-type: none"> • Advanced PVA material activates easily and quickly • Hook and loop closures • Conveniently attaches to hard hat suspension • Reusable, just rewet • Rinse before use 														
<table border="1"> <thead> <tr> <th>ITEM #</th> <th>SIZE</th> <th>COLOR</th> </tr> </thead> <tbody> <tr> <td>12597</td> <td>—</td> <td>Blue</td> </tr> </tbody> </table>			ITEM #	SIZE	COLOR	12597	—	Blue	// PATENTED			// PATENTED		
ITEM #	SIZE	COLOR												
12597	—	Blue												

6670_{CT}

ORDER MULTIPLE
6

COOLING TOWEL HARD HAT NECK SHADE

UPDATED FOR '16

- Advanced PVA material activates easily and quickly
- Re-usable: just re-wet
- Super-evaporative cooling process keeps you cool
- Hook and loop straps for easy attachment
- Rinse before use

ITEM #	SIZE	COLOR
12523	—	HV Lime

// PATENTED

6717_{CT}

ORDER MULTIPLE
6

HARD HAT PAD AND NECK SHADE

UPDATED FOR '16

- Advanced PVA material activates easily and quickly
- Hook and loop closures
- Protects neck from harmful UV rays
- Conveniently attaches to hard hat suspension
- Reusable, just rewet
- Rinse before use

ITEM #	SIZE	COLOR
12596	—	Blue

// PATENTED

8935_{CT}

ORDER MULTIPLE
6

COOLING TOWEL HI-VIS RANGER HAT

- Advanced PVA material lines the inside hat rim
- Easily activated by running under water for one minute
- ANSI certified 150D oxford polyester
- Level 2 ANSI-compliant tape with contrasting color
- Cooling sensation lasts up to 4 hours
- Rinse before use

ITEM #	SIZE	COLOR
12590	S/M	HV Lime
12591	L/XL	HV Lime

// PATENTED

6602

ORDER MULTIPLE
1

COOLING TOWEL

- Advanced PVA cooling technology
- Super-evaporative, feels cooler than ambient air
- Activates fast and easy - run under cold water
- Machine washable
- Size: 13" x 29.5" (33cm x 75cm)
- Rinse before use

ITEM #	SIZE	COLOR	ITEM #	SIZE	COLOR
12420	—	Blue	12442	—	Pink
12439	—	HV Lime	12438	—	Gray
12441	—	Orange			

// PATENTED

6603

ORDER MULTIPLE
12

COOLING TOWEL BAND

OHS
2015
NEW PRODUCT
OF THE YEAR

- Advanced PVA cooling technology
- Super-evaporative, feels cooler than ambient air
- Activates fast and easy - run under cold water
- Wear as neck wrap by pulling end through slit
- Size: 4" x 29.5" (10cm x 75cm)
- Rinse before use

ITEM #	SIZE	COLOR
12418	—	Blue

// PATENTED

6700_{CT}

ORDER MULTIPLE
6

COOLING BANDANA WITH TOWEL

- Advanced PVA material activates easily and quickly
- Re-usable: just rewet to re-activate
- Super-evaporative cooling process keeps you cool
- Tie closure
- Rinse before use

ITEM #	SIZE	COLOR	ITEM #	SIZE	COLOR
12561	—	Stars & Stripes	12567	—	Solid Blue
12563	—	Red Western	12562	—	Camo
12564	—	Navy Western	12568	—	Flames
12566	—	HV Lime	12569	—	Skulls

// PATENTED

	6700	ORDER MULTIPLE 24
---	-------------	-----------------------------

COOLING BANDANA





- Bandana/headband - tie closure
- Soak in water 2-5 minutes to activate
- Remains cool for up to 4 hours
- Re-usable: just soak in water to re-activate

ITEM #	SIZE	COLOR	ITEM #	SIZE	COLOR
12303	—	Stars & Stripes	12306	—	Navy Western
12304	—	Camouflage	12307	—	Solid Blue
12305	—	Red Western	12341	—	Flames
12301	—	HV Lime	12329	—	Skulls

	6705	ORDER MULTIPLE 24
---	-------------	-----------------------------

HOOK & LOOP COOLING BANDANA





- Hook and loop closure
- Soak in water 2-5 minutes to activate
- Remains cool for up to 4 hours
- Re-usable, just re-wet

ITEM #	SIZE	COLOR	ITEM #	SIZE	COLOR
12313	—	Stars & Stripes	12317	—	Solid Blue
12314	—	Camouflage	12321	—	HV Lime
12315	—	Red Western	12311	—	Flames
12316	—	Navy Western	12349	—	Skulls

	6710	ORDER MULTIPLE 24
---	-------------	-----------------------------

COOLING TRIANGLE HAT





- Triangle hat
- Soak in water 2-5 minutes to activate
- Re-usable: just soak in water to re-activate
- Tie closure

ITEM #	SIZE	COLOR	ITEM #	SIZE	COLOR
12323	—	Stars & Stripes	12327	—	Solid Blue
12324	—	Camouflage	12331	—	HV Lime
12325	—	Red Western	12328	—	Flames
12326	—	Navy Western	12359	—	Skulls

	6715	ORDER MULTIPLE 24
---	-------------	-----------------------------

COOLING HARD HAT PAD



- Lightweight, cooling acrylic polymers
- Hook and loop closures
- Conveniently attaches to hard hat suspension
- Soak in water 2-5 minutes to activate
- Remains cool for up to 4 hours

EM #	SIZE	COLOR
12337	—	Blue

	6716	ORDER MULTIPLE 24
---	-------------	-----------------------------

COOLING HARD HAT LINER



- Lightweight, cooling acrylic polymers
- Hook and loop closures
- Conveniently attaches to hard hat suspension
- Soak in water 2-5 minutes to activate
- Remains cool for up to 4 hours

ITEM #	SIZE	COLOR
12338	—	Blue

	6717	ORDER MULTIPLE 24
---	-------------	-----------------------------

COOL HARD HAT PAD WITH NECK SHADE





- Lightweight, cooling acrylic polymers
- Hook and loop closures
- Protects neck from harmful UV rays
- Conveniently attaches to hard hat suspension
- Soak in water 2-5 minutes to activate

ITEM #	SIZE	COLOR
12336	—	Blue

**CHILL-ITS® BANDANA
COLORS & PATTERNS:**

*Note: all colors not necessarily available in all styles. See specific product for listing.



Camo



Flames



Red Western



Navy Western

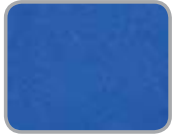

Blue



Hi-Vis Lime



Stars & Stripes

**CHILL-ITS® MULTI-BAND
COLORS & PATTERNS:**

*Note: all colors not necessarily available in all styles. See specific product for listing.



Stars & Stripes



Red Western



Navy Western



Hi-Vis Lime



Flames



Be Tenacious



Skulls



Navy

		6700_{FR}	ORDER MULTIPLE 6
FR COOLING BANDANA			
FR		NFPA 70E CAT 1	
		ATPV 7.1 CAL/CM²	
<ul style="list-style-type: none"> • Modacrylic cotton blend fabric • Fabric meets ASTM F1506 performance requirements • Meets ASTM F2302 for flame resistance • Soak in water 2-5 minutes to activate • Bandana/headband- tie closure 			
ITEM #	SIZE	COLOR	
12601	—	Hi-Vis Lime	
12607	—	Solid Blue	

		6705_{FR}	ORDER MULTIPLE 6
HOOK & LOOP FR COOLING BANDANA			
FR		NFPA 70E CAT 1	
		ATPV 7.1 CAL/CM²	
<ul style="list-style-type: none"> • Modacrylic cotton blend fabric • Fabric meets ASTM F1506 performance requirements • Meets ASTM F2302 for flame resistance • Soak in water 2-5 minutes to activate • Bandana/headband- hook and loop 			
ITEM #	SIZE	COLOR	
12611	—	Hi-Vis Lime	
12617	—	Solid Blue	

		6710_{FR}	ORDER MULTIPLE 6
FR COOLING TRIANGLE HAT			
FR		NFPA 70E CAT 1	
		ATPV 7.1 CAL/CM²	
<ul style="list-style-type: none"> • Modacrylic cotton blend fabric • Fabric meets ASTM F1506 performance requirements • Meets ASTM F2302 for flame resistance • Soak in water 2-5 minutes to activate • Triangle Hat 			
ITEM #	SIZE	COLOR	
12621	—	Hi-Vis Lime	
12627	—	Solid Blue	

		6717_{FR}	ORDER MULTIPLE 6
FR HARD HAT PAD WITH SHADE			
FR		NFPA 70E CAT 1	
		ATPV 7.1 CAL/CM²	
<ul style="list-style-type: none"> • Protects neck from harmful UV rays • Modacrylic cotton blend FR fabric • Fabric meets ASTM F1506 performance requirements • Meets ASTM F2302 for flame resistance • Soak in water 2-5 minutes to activate 			
ITEM #	SIZE	COLOR	
12657	—	Blue	

CHILL-ITS® COOLING:

EVAPORATIVE SERIES

DIFFERENTIATED BY DESIGN:

CONSTRUCTION

Lightweight, durable material ensures a comfortable fit all day.



DESIGN

Vest features hi-visibility fabric, YKK zippers, mesh panels for additional comfort and stretch.

COOLING TECHNOLOGY

Patented dry evaporative cooling technology activates easily with water- no refrigeration, gels or chemicals required. Capacity to cool up to 59° F // 15° C below ambient air temperatures.



6685

ORDER MULTIPLE
1

DRY EVAPORATIVE COOLING VEST



- Provides immediate and long lasting cooling
- Up to 3 days of cooling ability
- Activate with 13-20oz (400-600ml) water
- Lightweight, durable, and machine washable
- Easy to use, watertight filling cap

ITEM #	SIZE	COLOR	ITEM #	SIZE	COLOR
12673	M	HV Lime	12676	2XL	HV Lime
12674	L	HV Lime	12677	3XL	HV Lime
12675	XL	HV Lime	12678	4XL	HV Lime

// PATENTED



6665

ORDER MULTIPLE
1

EVAPORATIVE COOLING VEST



- Activated, polymer-embedded fabric inside
- Water-repellent liner
- Lightweight, durable, and washable
- Soak in water 2-5 minutes to activate
- Remains cool for up to 4 hours

ITEM #	SIZE	COLOR	ITEM #	SIZE	COLOR
12533	M	HV Lime	12543	M	Gray
12534	L	HV Lime	12544	L	Gray
12535	XL	HV Lime	12545	XL	Gray
12536	2XL	HV Lime	12546	2XL	Gray
12537	3XL	HV Lime	12547	3XL	Gray

BUT AT LEAST IT'S A DRY HEAT...

DRY VS. WET TECHNOLOGY EXPLAINED...

With more than 40 different cooling products to choose from in the Chill-Its® lineup, there have never been so many ways to cool down when the workzone starts to heat up. But why not just one more. This year we've added a new technology to our cooling quiver. We call it a Dry Vest. Yes, we've been preaching evaporation from the pulpit of cooling for decades, so now you're asking yourself WTF? Hang with us for a minute. Our trusted, tried, and true 6665 Evaporative Cooling Vest soaks up water and cools with the best of them using the evaporative process that powers most of our Chill-Its® product offering. But we've built a better mousetrap. We now have a patented "Dry Vest" to battle the heat. The outer and inner (next to the skin) layers are dry as the Sahara Desert. The inside chamber is where all the mysterious cooling science occurs. Simply open up the leak-free cap, fill with a half-liter of water, and you'll be cool as a cucumber for the rest of the afternoon...and well into the next day. All this with the added benefit of not soaking your workday clothes. Two cooling vests. Two technologies. One common solution - keeping your bad self the coolest on the work day block.



FIND OUT MORE ABOUT THE TECHNOLOGY THAT GOES INTO THE FULL LINE OF ERGODYNE COOLING PRODUCTS AT: WWW.ERGODYNE.COM

COOLING // DRY EVAPORATIVE TECHNOLOGY //

DRY evaporative cooling vest is a comfortable, lightweight and easy to (re)fill vest that puts the cool in cooling products. Did we mention it was DRY?

Activation: Fill vest with 400-600mL water, squeeze upward to activate.



Chill Factor: Cooling capacity of 59° F // 15° C below ambient air temperatures for up to 3 DAYS of chilling bliss.

COOLING // WET EVAPORATIVE TECHNOLOGY //

WET evaporative cooling vest is a super-absorbent wearable cooler that offers quick cooling relief.

Activation: Submerge in water 1-2 minutes, remove and blot dry.



Chill Factor: Cooling capacity of 64° for up to 4 hours of chilling bliss.

CHILL-ITS® COOLING:

ABSORPTIVE SERIES

DIFFERENTIATED BY DESIGN:

HIGH PERFORMANCE FABRIC

Technical fabric moves moisture away from body for fast evaporation.



ELASTIC

Elastic band components keep absorbent materials next to skin for an effective, secure fit.

TERRY CLOTH

Keeps perspiration out of eyes and away from hands for clearer vision and safer grips.

	6650	ORDER MULTIPLE 1									
HIGH-PERFORMANCE HAT WITH NECK SHADE											
<ul style="list-style-type: none"> • Hi Cool® moisture management performance fabric • Absorbent terry headband • Wide panel neck protection • Adjustable cinch cord for a great fit 											
<table border="1"> <thead> <tr> <th>ITEM #</th> <th>SIZE</th> <th>COLOR</th> </tr> </thead> <tbody> <tr> <td>12520</td> <td>—</td> <td>HV Lime</td> </tr> <tr> <td>12521</td> <td>—</td> <td>HV Orange</td> </tr> </tbody> </table>			ITEM #	SIZE	COLOR	12520	—	HV Lime	12521	—	HV Orange
ITEM #	SIZE	COLOR									
12520	—	HV Lime									
12521	—	HV Orange									

	6615	ORDER MULTIPLE 6																														
HIGH-PERFORMANCE DEW RAG																																
<ul style="list-style-type: none"> • Hi Cool® moisture management performance fabric • Comfortable to wear under hats, helmets, or alone • Absorbent terry headband • Elastic band for a great fit • Machine washable 																																
<table border="1"> <thead> <tr> <th>ITEM #</th> <th>SIZE</th> <th>COLOR</th> <th>ITEM #</th> <th>SIZE</th> <th>COLOR</th> </tr> </thead> <tbody> <tr> <td>12476</td> <td>—</td> <td>HV Lime</td> <td>12480</td> <td>—</td> <td>Navy Western</td> </tr> <tr> <td>12477</td> <td>—</td> <td>Stars & Stripes</td> <td>12481</td> <td>—</td> <td>Solid Blue</td> </tr> <tr> <td>12478</td> <td>—</td> <td>Camouflage</td> <td>12485</td> <td>—</td> <td>Flames</td> </tr> <tr> <td>12479</td> <td>—</td> <td>Red Western</td> <td>12519</td> <td>—</td> <td>Skulls</td> </tr> </tbody> </table>			ITEM #	SIZE	COLOR	ITEM #	SIZE	COLOR	12476	—	HV Lime	12480	—	Navy Western	12477	—	Stars & Stripes	12481	—	Solid Blue	12478	—	Camouflage	12485	—	Flames	12479	—	Red Western	12519	—	Skulls
ITEM #	SIZE	COLOR	ITEM #	SIZE	COLOR																											
12476	—	HV Lime	12480	—	Navy Western																											
12477	—	Stars & Stripes	12481	—	Solid Blue																											
12478	—	Camouflage	12485	—	Flames																											
12479	—	Red Western	12519	—	Skulls																											

	6630	ORDER MULTIPLE 6																														
HIGH-PERFORMANCE SKULL CAP																																
<ul style="list-style-type: none"> • Hi Cool® moisture management performance fabric • Comfortable to wear under hats, helmets, or alone • Wide, absorbent terrycloth band • One size fits most • Machine washable 																																
<table border="1"> <thead> <tr> <th>ITEM #</th> <th>SIZE</th> <th>COLOR</th> <th>ITEM #</th> <th>SIZE</th> <th>COLOR</th> </tr> </thead> <tbody> <tr> <td>12505</td> <td>—</td> <td>HV Lime</td> <td>12509</td> <td>—</td> <td>Navy Western</td> </tr> <tr> <td>12506</td> <td>—</td> <td>Stars & Stripes</td> <td>12510</td> <td>—</td> <td>Solid Blue</td> </tr> <tr> <td>12507</td> <td>—</td> <td>Camouflage</td> <td>12514</td> <td>—</td> <td>Flames</td> </tr> <tr> <td>12508</td> <td>—</td> <td>Red Western</td> <td>12529</td> <td>—</td> <td>Skulls</td> </tr> </tbody> </table>			ITEM #	SIZE	COLOR	ITEM #	SIZE	COLOR	12505	—	HV Lime	12509	—	Navy Western	12506	—	Stars & Stripes	12510	—	Solid Blue	12507	—	Camouflage	12514	—	Flames	12508	—	Red Western	12529	—	Skulls
ITEM #	SIZE	COLOR	ITEM #	SIZE	COLOR																											
12505	—	HV Lime	12509	—	Navy Western																											
12506	—	Stars & Stripes	12510	—	Solid Blue																											
12507	—	Camouflage	12514	—	Flames																											
12508	—	Red Western	12529	—	Skulls																											

	6605	ORDER MULTIPLE 6																														
HIGH-PERFORMANCE HEADBAND																																
<ul style="list-style-type: none"> • Hi Cool® moisture management performance fabric • Absorbent terry headband • Elasticized back for a great fit • Machine washable 																																
<table border="1"> <thead> <tr> <th>ITEM #</th> <th>SIZE</th> <th>COLOR</th> <th>ITEM #</th> <th>SIZE</th> <th>COLOR</th> </tr> </thead> <tbody> <tr> <td>12421</td> <td>—</td> <td>Stars & Stripes</td> <td>12425</td> <td>—</td> <td>Solid Blue</td> </tr> <tr> <td>12422</td> <td>—</td> <td>Camouflage</td> <td>12429</td> <td>—</td> <td>Flames</td> </tr> <tr> <td>12423</td> <td>—</td> <td>Red Western</td> <td>12431</td> <td>—</td> <td>HV Lime</td> </tr> <tr> <td>12424</td> <td>—</td> <td>Navy Western</td> <td>12489</td> <td>—</td> <td>Skulls</td> </tr> </tbody> </table>			ITEM #	SIZE	COLOR	ITEM #	SIZE	COLOR	12421	—	Stars & Stripes	12425	—	Solid Blue	12422	—	Camouflage	12429	—	Flames	12423	—	Red Western	12431	—	HV Lime	12424	—	Navy Western	12489	—	Skulls
ITEM #	SIZE	COLOR	ITEM #	SIZE	COLOR																											
12421	—	Stars & Stripes	12425	—	Solid Blue																											
12422	—	Camouflage	12429	—	Flames																											
12423	—	Red Western	12431	—	HV Lime																											
12424	—	Navy Western	12489	—	Skulls																											

	6660	ORDER MULTIPLE 6
--	------	-------------------------------

HARD HAT BRIM WITH SHADE

UPDATED FOR
'16

- 100% polyester fabric
- Universal design - elastic inner rim to fit most hard hats
- Blocks the sun's rays keeping workers comfortable
- Longer, length

ITEM #	SIZE	COLOR
12640	—	HV Lime
12641	—	HV Orange

// PATENTED

	6500/6550	ORDER MULTIPLE 6
--	-----------	-------------------------------

TERRY SWEATBAND

- Thick, absorbent cotton terry
- Elastic maintains snug fit

6500: WRIST SWEATBAND			6550: HEAD SWEATBAND		
ITEM #	SIZE	COLOR	ITEM #	SIZE	COLOR
12400	—	White	12450	—	White
12402	—	Black	12452	—	Black

	6609	ORDER MULTIPLE 24
--	------	--------------------------------

TERRY SWEATBAND

- Absorbent terry headband
- Fits most hard hat suspension systems
- Machine washable
- 100% cotton

ITEM #	SIZE	COLOR
12440	—	Gray

	6607	ORDER MULTIPLE 100
--	------	---------------------------------

SPONGE SWEATBAND

- Cellulose, absorbent sponge band
- Elasticized back for a great fit
- Contains latex
- Hand wash
- Rinse before use

ITEM #	SIZE	COLOR
12436	—	Blue

	6485	ORDER MULTIPLE 1
--	------	-------------------------------

MULTI-BAND

UPDATED FOR
'16

- Multiple style and usage configurations
- Moisture management performance fabric dries fast
- Anti-stink treatment helps workers remain unscented
- Stretchable, comfortable, and seam-free
- Blocks wind, sun, and dust

ITEM #	SIZE	COLOR	ITEM #	SIZE	COLOR
42103	—	Stars & Stripes	42111	—	Flames
42105	—	Red Western	42112	—	Skulls
42106	—	Navy Western	42119	—	Be Tenacious
42108	—	HV Lime			

	6486	ORDER MULTIPLE 1
--	------	-------------------------------

FR MULTI-BAND

FR
🔥

NFPA 70E CAT 1
 ATPV 4.2 CAL/CM²

- Inherently FR Nomex® knit fabric
- Meets requirements of ASTM F1506
- Classified CAT 1 according to NFPA 70E
- Anti-stink treatment helps workers remain unscented
- Multi-climate usage
- Stretchable, comfortable, and seam-free

ITEM #	SIZE	COLOR
42201	—	Navy

CHILL-ITS® COOLING:

PHASE CHANGE SERIES

DIFFERENTIATED BY DESIGN:

FLAME RESISTANT

Optional models with inherent modacrylic fabric meets ASTM F1506 performance requirements; classified CAT 1 per NFPA 70E.

PHASE CHANGE MATERIAL

Non-toxic, non-carcinogenic dielectric substance maintains a constant 64° F // 18° C temperature.

ADJUSTABLE FIT

Elastic straps and hook and loop closures let workers adjust the fit for optimal comfort.

HI-VISIBILITY

Optional models with ANSI-certified fabric and retro reflective tape offer conspicuity AND cool comfort.



6215HV

WHAT IS THIS THING, ANYWAY?

UP CLOSE & PERSONAL WITH THE PHASE CHANGE VEST:

- KEEPS WORKERS COOL + PRODUCTIVE
- 64° F // 18° C ONLY. NO MORE. NO LESS. LASTS FOR UP TO 4 HOURS REGARDLESS OF OUTSIDE TEMP
- FR PROTECTION ON PREMIUM MODELS
- IDEAL FOR EXTREME HEAT APPLICATIONS: FOUNDRIES, GLASS MANUFACTURING, PAPER AND PULP



CHARGE PACK

ACTIVATED CHARGE PACK

		6215	ORDER MULTIPLE 1
PREMIUM PHASE CHANGE VEST			
		NFPA 70E CAT 1 ATPV 7.1 CAL/CM²	
<ul style="list-style-type: none"> • Maintains constant 64°F / 18°C • Cooling lifecycle lasts up to four hours • Modacrylic cotton blend FR fabric • Extended vest surface area enhances cooling power • Fabric meets ASTM F1506; Classified to NFPA (CAT 1) 			
VEST+PACKS		VEST ONLY	
ITEM #	SIZE	COLOR	
12200	S/M	Khaki	12203 S/M Khaki
12201	L/XL	Khaki	12204 L/XL Khaki

		6215 _{HV}	ORDER MULTIPLE 1
HI-VIS PREMIUM PHASE CHANGE VEST			
		NFPA 70E CAT 1 ATPV 7.1 CAL/CM²	
<ul style="list-style-type: none"> • Maintains constant 64°F / 18°C • Cooling lifecycle lasts up to four hours • Modacrylic cotton blend FR fabric • Extended vest surface area enhances cooling power • Fabric meets ASTM F1506; Classified to NFPA (CAT 1) 			
VEST+PACKS		VEST ONLY	
ITEM #	SIZE	COLOR	
12220	S/M	HV Orange	12205 S/M HV Orange
12221	L/XL	HV Orange	12206 L/XL HV Orange

		6230	ORDER MULTIPLE 1
STANDARD PHASE CHANGE VEST			
<ul style="list-style-type: none"> • Maintains constant 64°F / 18°C • Cooling lifecycle lasts up to four hours • Comfortable cotton construction • Extended vest surface area enhances cooling power • Non-toxic, non carcinogenic, dielectric substance 			
VEST+PACKS		VEST ONLY	
ITEM #	SIZE	COLOR	
12000	S/M	Khaki	12003 S/M Khaki
12010	L/XL	Khaki	12004 L/XL Khaki

		6240	ORDER MULTIPLE 1
VEST EXTENDERS			
<ul style="list-style-type: none"> • 100% elastic hook and loop extenders • .5" (9cm) elastic width for more stretch 			
ITEM #	SIZE	COLOR	
12209	—	HV Orange	
12208	—	Black	

		6220	ORDER MULTIPLE 1
REPLACEMENT CHARGE PACKS			
<ul style="list-style-type: none"> • Maintains constant 64°F / 18°C • Cooling lifecycle lasts up to four hours • Honeycomb design for increased flexibility 			
ITEM #	SIZE	COLOR	
12201	S/M	Clear	
12202	L/XL	Clear	

// PATENTED

CHILL-ITS® COOLING:

HYDRATION SERIES

DIFFERENTIATED BY DESIGN:

600D RIP STOP POLYESTER SHELL

Durable and water-resistant 600D rip stop polyester shell protects hydration pack from wear and tear.

BREAKAWAY SHOULDER STRAPS

Breakaway shoulder straps for additional security.



5156

5158

TPE BLADDER

TPE eliminates plastic odor and taste and stays supple to withstand daily wear and tear.

LARGE COVERED CAP

Big mouth cap for easy refilling and ice cube loading. Zip up cover keeps out debris and contaminants.

OPTIONAL PUMP

Get hydrated faster! Shower yourself with cooling goodness.



5157

ORDER MULTIPLE 1

PREMIUM CARGO HYDRATION PACK



- Durable 600D water-resistant rip stop polyester
- Vented straps and back for maximum breathability
- 8mm EVA foam padding on shoulder straps
- 5 zippered compartments, D-rings, and webbing
- 100% anti-microbial bite valve with cover to protect

ITEM #	SIZE	COLOR
13163	2L	Black
13164	2L	HV Lime



5156

ORDER MULTIPLE 1

PREMIUM LOW PROFILE HYDRATION PACK



- Durable 600D water-resistant rip stop polyester
- Vented straps and back for maximum breathability
- 8mm EVA foam padding on shoulder straps
- Zippered compartment, D-rings, and webbing
- Insulated pack and tube keeps water cool

ITEM #	SIZE	COLOR
13161	2L	Black
13162	2L	HV Lime



	5155	ORDER MULTIPLE 1
LOW PROFILE HYDRATION PACK		
<ul style="list-style-type: none"> • Durable 600D water-resistant rip stop polyester • Insulated pack and tube keeps water cool • 100% anti-microbial bite valve with cover • Breakaway shoulder straps for additional security 		
ITEM #	SIZE	COLOR
13155	2L	Black

	5155_{HV}	ORDER MULTIPLE 1
HI-VIS LOW PROFILE HYDRATION PACK		
<ul style="list-style-type: none"> • Durable 600D water-resistant rip stop polyester • Insulated pack and tube keeps water cool • 100% anti-microbial bite valve with cover • Breakaway shoulder straps for additional security • Wide mouth opening for easy filling and cleaning 		
ITEM #	SIZE	COLOR
13156	2L	HV Lime
13157	2L	HV Orange

	5158	ORDER MULTIPLE 1
HYDRATION PACK PRESSURE PUMP		
<ul style="list-style-type: none"> • FDA approved food grade silicone body • Elastic strap for secure fit • Valve cover keeps debris off bulb tip • Fits with all Chill-Its® Hydration Packs 		
ITEM #	SIZE	COLOR
13158	—	Blue

	5151	ORDER MULTIPLE 1
PLASTIC WIDE MOUTH WATER BOTTLE		
<ul style="list-style-type: none"> • Impact-resistant tritan copolyester plastic • Odor resistant, durability to high heat and humidity • Wide mouth to easily fit ice cubes • Dishwasher safe • BPA free 		
ITEM #	SIZE	COLOR
13151	1L	Orange
13152	1L	Gray
13153	1L	Lime

	5580	ORDER MULTIPLE 1
PALS WATER BOTTLE POUCH		
<ul style="list-style-type: none"> • 1200D ballistic polyester w/ PVC backing • Fastening straps for connection to PALS webbing • Side zipper pocket for storing powder sticks • YKK zippers • Fits the Chill-Its® 5151 Water Bottle 		
ITEM #	SIZE	COLOR
13680	—	Black

	5581	ORDER MULTIPLE 1
PALS MODULAR HYDRATION PACK		
<ul style="list-style-type: none"> • 1200D ballistic polyester w/ PVC backing • Fastening straps for connection to PALS webbing • Bite valve cover for protection from contaminants • Capacity: 1L (1000ML) / 32oz / 1.1 hours 		
ITEM #	SIZE	COLOR
13681	1L	Black



SHAX® WORK SHELTERS

Every now and then the elements range from inclement to apocalyptic. So if you find yourself caught short out in the wild we give you SHAX® Work Shelters. These beauties provide a safe haven when the sun bakes, skies pour, and the wind howls. UV blocking, PU-coated, and equipped with a roller bag, these mobile and easy to set up shelters are your go-to for relief from the wrath of the great outdoors.

WORK SHELTERS // POP-UP SERIES



6000 Heavy-Duty Commercial Tent



6010 Lightweight Tent

WORK SHELTERS // UMBRELLA SERIES



6100 Lightweight Umbrella

WORK SHELTERS // ACCESSORIES



6094 Tent Weight Bags



6098 Side Panel



6191 Umbrella Suction Cup Clamps



6190 Umbrella Stand



3 LITTLE PIGS APPROVED.

SHAX® WORK SHELTERS:

POP-UP SERIES

DIFFERENTIATED BY DESIGN:

CANOPY VENTING

Double vented canopy for ventilation and easy airflow.

CANOPY

UV coating to block sun's rays and a PU coating to protect from the harshest elements.

REFLECTIVE AND REINFORCED

Reflective accents makes for great visibility during low light hours and reinforced corner provide additional durability at pressure points.

10x10 FOOTPRINT

10x10 footprint, versatile and durable shelter that provides long lasting relief from sun, wind, and rain.

ADJUSTABLE MECHANICS

Easy adjustable features for quick, convenient height adjustment.



6000

What is CPAI-84??

CPAI-84 is a flammability specification, written by Industrial Fabrics Association International (say that ten times fast!) as a voluntary industry specification. CPAI-84 (Canvas Products Association International) standard is widely used in the industry and has been adopted by states like California and New Jersey. It provides test methods for evaluating flame resistance of fabric and other pliable materials in camping tentage. It also provides performance criteria and certification guidelines for suppliers (that's us!) and labeling requirements that identify a tent as being constructed of flame resistant material and caution against action detrimental to the flame-retardant finishes.

6000

ORDER MULTIPLE
1

HEAVY-DUTY COMMERCIAL TENT

- 10'x10' area, ABS sliders for peak height of 14'
- Poly canopy w/ PU & UV treatments and vented top
- Powder coated steel frame
- Heavy-duty ground stakes and ropes included
- Wheel bag for easy storage and transport, 46lbs

ITEM #	SIZE	COLOR	DESCRIPTION
12900	10' x 10'	HV Lime	Heavy-Duty Tent
12998	—	HV Lime	Optional Side Panel
12901	10' x 10'	HV Lime	Replacement Canopy
12902	—	Black	Replacement Bag

6010

ORDER MULTIPLE
1

LIGHTWEIGHT TENT

- 10'x10' area, pull pins for peak height of 14'
- Poly top with PU coating, meets CPAI-84 code
- Reinforced corners
- Hammer tone steel frame
- Wheeled bag for storage and transport, 44lbs

ITEM #	SIZE	COLOR	DESCRIPTION
12910	10' x 10'	HV Lime	Lightweight Tent
12998	—	HV Lime	Optional Side Panel
12911	10' x 10'	HV Lime	Replacement Canopy

6094

ORDER MULTIPLE
1

TENT WEIGHT BAGS

- Polyester bags with water-resistant PU backing
- Easy-to-carry poly handle, 40 lbs capacity
- Funnel design, offering a wide opening
- Hook and loop for a secure fit around tent leg
- Works with 6000, 6010 & 6190 models

ITEM #	SIZE	COLOR
12994	2/pk	Black

// PATENTED

6100

ORDER MULTIPLE
1

LIGHTWEIGHT INDUSTRIAL UMBRELLA

OPTIONAL UMBRELLA STAND (6190)

- Size: 84" diameter, peak height of 92"
- Poly canopy w/ PU & UV treatments and vented top
- Meets CPAI-84 flame resistance code
- Powder coated steel pole and ribs, tilt mechanism
- Includes oversized storage bag and ground spike

ITEM #	SIZE	COLOR
12967	84"	HV Lime

6191

ORDER MULTIPLE
1

UMBRELLA SUCTION CUP CLAMPS

- Works with any metal structure
- 4 suction cups pack into a 5130 Bag
- Non-conductive materials

ITEM #	SIZE	COLOR
12991	—	n/a

// PATENTED

6190

ORDER MULTIPLE
1

UMBRELLA STAND

- Powder coated steel construction
- Hinged legs fold making stand easy to use and store
- Place 6100 umbrella in top for stability

ITEM #	SIZE	COLOR
12990	—	Black



N-FERNO[®] FR 



N-FERNO[®]

WARMING PRODUCTS

**BRACE YOURSELF:
WINTER IS COMING.**



N-FERNO® WARMING PRODUCTS

Turn the frozen tundra into a disco inferno. When the frost comes out you'll burn, baby, burn with N-Ferno® Warming Products. Developed to withstand the unpredictable cold snaps and whipping winds of winter these threads make Siberia feel like Studio 54. And with our thermal options there's no excuse to freeze your buns off waiting to get into the club. Sorry, goldfish platforms not available.

WARMING PRODUCTS // HEATED CLOTHING & ACC. SERIES



6490 Heated Jacket

WARMING PRODUCTS // THERMAL CLOTHING SERIES



6465 Thermal / Jacket



6463 Thermal / Vest

WARMING PRODUCTS // THERMAL LINER SERIES



6873 3-Layer w/ Banox



6877 3-Layer w/ Banox



6863 3-Layer Liner w/ Fleece



6867 3-Layer Liner w/ Fleece

WARMING PRODUCTS // THERMAL LINER SERIES



6890 3-Layer FR Liner



6892 3-Layer FR Liner



6860 2-Layer w/ Banox



6862 2-Layer w/ Banox

WARMING PRODUCTS // THERMAL BALACLAVA SERIES



6970 Hot Rox Balaclava



6825 Nomex FR Balaclava



6828 Modacrylic FR Balaclava



6823 WP Hinged Balaclava

WARMING PRODUCTS // THERMAL HAT & CAP SERIES



6818 Knit Cap



6819BT Knit Cap



6820 FR Knit Cap



6802 Classic Trapper™ Hat



6470 Thermal / Bib



6480 Thermal / Ripped Fit



6435 Thermal / Ripped Fit / LS



6950 3-Layer Liner w/ Sherpa Fleece



6952 3-Layer Liner w/ Sherpa Fleece



6885 2-Way FR Liner



6880 2-Layer FR Liner



6882 2-Layer FR Liner



6850 2-Layer Liner w/ Fleece



6852 2-Layer Liner w/ Fleece



6840 2-Layer Econo



6842 2-Layer Econo



6870 2-Layer Mouth Pc.



6872 2-Layer FR Mouth Pc.



6824 Wool Blend Balaclava



6827 2-Pc. Neoprene Balaclava



6826 2-Pc. Fleece Balaclava



6822 Spandex Top Balaclava



6821 Fleece Balaclava



6810 Half Stretch Cap



6815 Full Stretch Cap

WARMING PRODUCTS // ACCESSORIES



6990/6992 Hand & Toe Warming Packs

NEW FOR '16



6995 Foot Warming Packs

N-FERNO® WARMING PRODUCTS:

HEATED CLOTHING & ACC. SERIES

DIFFERENTIATED BY DESIGN:

WATER AND WIND RESISTANT

Water and wind resistant outer shell provides protection from the harshest elements.

YKK ZIPPERS

Heavy duty zippers from the top zipper makers in the world.



TWO HEAT ZONES

Two heat zones distribute heat to the core body regions: chest and back.

THREE HEAT SETTINGS

High, medium, and low heat settings provide customizable warmth.

6490

7.4V LITHIUM ION BATTERY

7.4V Lithium Ion Battery provides up to 9 hours of continuous heat on low setting, 5 hours on medium setting, and 3 hours on high setting.



FIND OUT MORE ABOUT THE TECHNOLOGY THAT GOES INTO
THE FULL LINE OF ERGODYNE WARMING PRODUCTS: WWW.ERGODYNE.COM

	6490	ORDER MULTIPLE 1		<p>6490: HEATED JACKET KIT</p> <table border="1" style="width: 100%; border-collapse: collapse;"> <thead> <tr> <th>ITEM #</th> <th>SIZE</th> <th>COLOR</th> </tr> </thead> <tbody> <tr><td>41403</td><td>M</td><td>Black</td></tr> <tr><td>41404</td><td>L</td><td>Black</td></tr> <tr><td>41405</td><td>XL</td><td>Black</td></tr> <tr><td>41406</td><td>2XL</td><td>Black</td></tr> <tr><td>41407</td><td>3XL</td><td>Black</td></tr> </tbody> </table> <p>* Includes Heated Jacket, 7.4 Lithium Ion Battery, and Wall Charger</p> <p>6490J: JACKET REPLACEMENT</p> <table border="1" style="width: 100%; border-collapse: collapse;"> <thead> <tr> <th>ITEM #</th> <th>SIZE</th> <th>COLOR</th> </tr> </thead> <tbody> <tr><td>41303</td><td>M</td><td>Black</td></tr> <tr><td>41304</td><td>L</td><td>Black</td></tr> <tr><td>41305</td><td>XL</td><td>Black</td></tr> <tr><td>41306</td><td>2XL</td><td>Black</td></tr> <tr><td>41307</td><td>3XL</td><td>Black</td></tr> </tbody> </table>	ITEM #	SIZE	COLOR	41403	M	Black	41404	L	Black	41405	XL	Black	41406	2XL	Black	41407	3XL	Black	ITEM #	SIZE	COLOR	41303	M	Black	41304	L	Black	41305	XL	Black	41306	2XL	Black	41307	3XL	Black
ITEM #	SIZE	COLOR																																						
41403	M	Black																																						
41404	L	Black																																						
41405	XL	Black																																						
41406	2XL	Black																																						
41407	3XL	Black																																						
ITEM #	SIZE	COLOR																																						
41303	M	Black																																						
41304	L	Black																																						
41305	XL	Black																																						
41306	2XL	Black																																						
41307	3XL	Black																																						

HEATED JACKET WITH REMOVABLE SLEEVES

- 2 heat zones: front (chest) and back
- 3 heat settings: high, medium, low
- Preheat mode option for increased warm-up time
- Up to 9 hours of continuous heat
- Battery: 7.4V, 5200 mAh lithium ion battery



2 HEAT ZONES



ZIP OFF SLEEVES



EASY TOUCH HEAT CONTROL BUTTON

2 HEAT ZONES

BATTERY HOLDER POCKET WITH 7.4V 5200 MAH LITHIUM ION BATTERY



ADDITIONAL REPLACEMENT PARTS & ACCESSORIES:

	6490 _B	ORDER MULTIPLE 1
<p>REPLACEMENT BATTERY</p>		
<ul style="list-style-type: none"> • Rechargeable lithium ion battery: 7.4V, 5200 mAh 		
ITEM #	SIZE	COLOR
41501	—	Black

	6490 _W	ORDER MULTIPLE 1
<p>REPLACEMENT WALL CHARGER</p>		
<ul style="list-style-type: none"> • Compatible with 7.4V lithium ion battery 		
ITEM #	SIZE	COLOR
41502	—	Black

	6490 _C	ORDER MULTIPLE 1
<p>CIGARETTE CONVERTER</p>		
<ul style="list-style-type: none"> • Allows user to heat jacket without battery 		
ITEM #	SIZE	COLOR
41503	—	Black

N-FERNO® WARMING PRODUCTS:

THERMAL SERIES

DIFFERENTIATED BY DESIGN:



ARMORTEX™ REINFORCEMENT

Located on high wear areas and made of a Kevlar® that is tear-resistant, rub-proof, and heat-friction resistant.

WATER AND WIND RESISTANT

Tough outer shell with DWR finish and PU coating to keep the body warm and dry.

YKK ZIPPERS

Heavy duty zippers from the top zipper makers in the world.

REFLECTIVE ACCENTS

Retro reflective details to help keep workers safe and seen.

6465

ARMORTEX™ REINFORCEMENT

Located on high wear areas and made of a Kevlar® that is tear-resistant, rub-proof, and heat-friction resistant.

6470

6465

ORDER
MULTIPLE
1

OUTER LAYER/THERMAL/JACKET

- Rugged 300D poly shell w/ PU & UV treatments
- Soft, warm fleece lining
- Armortex™ reinforcement zones in heavy wear areas
- Storm flap front
- 5 pockets including back document and front cell

ITEM #	SIZE	COLOR	ITEM #	SIZE	COLOR
41102	S	Black	41105	XL	Black
41103	M	Black	41106	2XL	Black
41104	L	Black	41107	3XL	Black

6463

ORDER
MULTIPLE
1

OUTER LAYER/THERMAL/VEST

- Rugged 300D poly shell w/ PU & UV treatments
- Soft, warm fleece lining
- Armortex™ reinforcement zones in heavy wear areas
- Storm flap front
- 5 pockets including back document and front cell

ITEM #	SIZE	COLOR	ITEM #	SIZE	COLOR
41002	S	Black	41005	XL	Black
41003	M	Black	41006	2XL	Black
41004	L	Black	41007	3XL	Black

6470

ORDER
MULTIPLE
1

OUTER LAYER/THERMAL/BIB

- 500D nylon shell provides element protection
- Armortex™ reinforcement zones in heavy wear areas
- Several pockets including hip and chest
- Removable PE foam knee/shin pads
- “Be Tenacious” non-slip, adjustable elastic straps

ITEM #	SIZE	COLOR	ITEM #	SIZE	COLOR
41203	M	Black	41206	2XL	Black
41204	L	Black	41207	3XL	Black
41205	XL	Black			

6435

ORDER
MULTIPLE
1

BASE LAYER/THERMAL/RIPPED FIT MOCK T

- Medium weight wicking fabrics for warmth
- Anti-stink treatment helps workers remain unscented
- Raglan sleeves, flat seams, long tail cut
- Soil release treatments make cleaning easy
- UPF 50 for protection against harmful UV

ITEM #	SIZE	COLOR	ITEM #	SIZE	COLOR
40203	M	Black	40206	2XL	Black
40204	L	Black	40207	3XL	Black
40205	XL	Black			

6480

ORDER
MULTIPLE
1

BASE LAYER/THERMAL/RIPPED FIT

- Medium weight wicking fabric for warmth
- Anti-stink treatment helps workers remain unscented
- Stretch fabrics, flat seams, tagless waistband
- Soil release treatments make cleaning easy
- UPF 50 for protection against harmful UV

ITEM #	SIZE	COLOR	ITEM #	SIZE	COLOR
40803	M	Black	40806	2XL	Black
40804	L	Black	40807	3XL	Black
40805	XL	Black			

N-FERNO® WARMING PRODUCTS:

THERMAL LINER SERIES

DIFFERENTIATED BY DESIGN:

HOOK AND LOOPS

Hook and loop detail to secure into a hard hat suspension for ultimate warmth during those cold fall and winter days.

REFLECTIVE DETAIL

Reflective accent for visibility when in low light conditions.

WARMING PACK POCKETS

For extra warmth during those cold winter days, place a warming pack into the liner pocket and enjoy hours of toasty relief.

LAYERING DETAILS

Layering systems allow you to choose the product that is right for your climate needs. More the layers, more the warmth.

FLAME RESISTANT AND NON FLAME RESISTANT OPTIONS

Depending on your needs, stay toasty warm and flame free in FR liners - you've got options!



6885



FIND OUT MORE ABOUT THE TECHNOLOGY THAT GOES INTO THE FULL LINE OF ERGODYNE WARMING PRODUCTS AT: WWW.ERGODYNE.COM

	6873/6877	ORDER MULTIPLE 12
3-LAYER LINER		
6873	6877	
<ul style="list-style-type: none"> • Shell: FR modacrylic blend • Mid-Layer: foam • Lining: 100% polyester fleece • Warming pack pockets / hook and loop straps 		
6873: REGULAR LENGTH		6877: SHOULDER LENGTH
ITEM #	SIZE	COLOR
16873	—	Black
ITEM #	SIZE	COLOR
16877	—	Black

	6863/6867	ORDER MULTIPLE 12
3-LAYER LINER		
6863	6867	
<ul style="list-style-type: none"> • Shell: 100% quilted nylon • Mid-Layer: foam • Lining: 100% polyester fleece • Warming pack pockets / hook and loop straps 		
6863: REGULAR LENGTH		6867: SHOULDER LENGTH
ITEM #	SIZE	COLOR
16863	—	Black
ITEM #	SIZE	COLOR
16867	—	Black

	6950/6952	ORDER MULTIPLE 12
3-LAYER LINER		
6950	6952	
<ul style="list-style-type: none"> • Shell: 100% quilted nylon • Mid-Layer: foam • Lining: 100% polyester sherpa • Warming pack pockets / hook and loop straps 		
6950: REGULAR LENGTH		6952: SHOULDER LENGTH
ITEM #	SIZE	COLOR
16950	—	Black
ITEM #	SIZE	COLOR
16952	—	Black

	6885	ORDER MULTIPLE 6
FR TWO-WAY 2-LAYER LINER		
FR	NFPA 70E CAT 2	
	ATPV 17 CAL/CM ²	
<ul style="list-style-type: none"> • Top: modacrylic twill with modacrylic fleece • Lower: double layer modacrylic rib knit • Nomex® Metal Zipper • Warming pack pockets / hook and loop straps • Meets ASTM F1506; classified to NFPA 70E (CAT 2) 		
ITEM #	SIZE	COLOR
16885	—	Black

	6880/6882	ORDER MULTIPLE 6
FR 2-LAYER LINER		
FR	NFPA 70E CAT 2	
	ATPV 20 CAL/CM ²	
6880	6882	
<ul style="list-style-type: none"> • Shell: modacrylic blend • Lining: modacrylic blend fleece • Warming pack pockets / hook and loop straps • Meets ASTM F1506; classified to NFPA 70E (CAT 2) 		
6880: REGULAR LENGTH		6882: SHOULDER LENGTH
ITEM #	SIZE	COLOR
16880	—	Black
ITEM #	SIZE	COLOR
16882	—	Black

	6890/6892	ORDER MULTIPLE 6
FR 3-LAYER LINER		
FR	NFPA 70E CAT 3	
	ATPV 27 CAL/CM ²	
6890	6892	
<ul style="list-style-type: none"> • Shell: modacrylic cotton blend twill • Mid-Layer: 3M™ FR Thinsulate™ • Lining: modacrylic cotton blend fleece • Warming pack pockets / hook and loop straps • Meets ASTM F1506 and classified to NFPA (CAT 3) 		
6890: REGULAR LENGTH		6892: SHOULDER LENGTH
ITEM #	SIZE	COLOR
16890	—	Black
ITEM #	SIZE	COLOR
16892	—	Black

	6860/6862	ORDER MULTIPLE 12
2-LAYER LINER W/ FR COTTON SHELL		
6860		6862
<ul style="list-style-type: none"> • Shell: FR modacrylic blend • Lining: 100% polyester fleece • Warming pack pockets / hook and loop straps 		
6860: REGULAR LENGTH		6862: SHOULDER LENGTH
ITEM #	SIZE	COLOR
16860	—	Black
ITEM #	SIZE	COLOR
16862	—	Black

	6850/6852	ORDER MULTIPLE 12
2-LAYER LINER		
6850		6852
<ul style="list-style-type: none"> • Shell: 100% cotton twill • Lining: 100% polyester fleece • Warming pack pockets / hook and loop straps 		
6850: REGULAR LENGTH		6852: SHOULDER LENGTH
ITEM #	SIZE	COLOR
16850	—	Black
ITEM #	SIZE	COLOR
16852	—	Black

	6840/6842	ORDER MULTIPLE 12
2-LAYER LINER - ECONO		
6840		6842
<ul style="list-style-type: none"> • Shell: 100% polyester with PU coating • Lining: 100% polyester fleece • Warming pack pockets / hook and loop straps 		
6840: REGULAR LENGTH		6842: SHOULDER LENGTH
ITEM #	SIZE	COLOR
16840	—	Black
ITEM #	SIZE	COLOR
16842	—	Black

	6870	ORDER MULTIPLE 12
2-LAYER MOUTH PIECE		
<ul style="list-style-type: none"> • 2-Layer, adjustable mouthpiece-cotton/fleece • Shell: 100% cotton twill • Lining: 100% polyester fleece • Hook and loop closure • Attach to winter liner for face coverage 		
ITEM #	SIZE	COLOR
16870	—	Black

	6872	ORDER MULTIPLE 6
FR-2-LAYER MOUTHPIECE		
<div style="background-color: black; color: white; padding: 5px; display: inline-block;"> FR NFPA 70E CAT 2 ATPV 20 CAL/CM² </div>		
<ul style="list-style-type: none"> • 2-Layer, adjustable mouthpiece • Shell: modacrylic cotton blend twill • Lining: modacrylic cotton blend fleece • Meets ASTM F1506; classified to NFPA 70E (CAT 2) • Attach to a winter liner for face coverage 		
ITEM #	SIZE	COLOR
16872	—	Black



DANGER STARTS WELL BEFORE ZERO //

Cold Stress is just as dangerous as Heat Stress — but with its sneaky symptoms, it often goes undetected until it's too late. Awareness is key. Being informed about the dangers of Cold Stress and the importance of breathing warm air can help save lives and keep workers warm, comfortable, and productive.



FROST BITE

SYMPTOMS: PALE, WAXY-WHITE SKIN COLOR; SKIN BECOMES HARD AND NUMB; USUALLY AFFECTS EXTREMITIES INCLUDING EARS AND NOSE.

RESPONSE:

- Move the person to a warm dry area and remove any wet/tight clothing that may cut off blood circulation.
- DO NOT rub the affected area, rubbing can cause skin/tissue damage.
- Gently place the affected area in warm (105°F) water. Do not pour water directly on affected area. Warming will take 25-40 mins.
- Once normal feeling, movement and color return to area, dry and wrap to keep warm.
- Seek medical attention as soon as possible.

HYPOTHERMIA

SYMPTOMS: FATIGUE/DROWSINESS; UNCONTROLLED SHIVERING; COOL BLUISH SKIN; SLURRED SPEECH; CLUMSY MOVEMENTS; IRRITABLE/IRRATIONAL/CONFUSED BEHAVIOR.

RESPONSE:

- CALL FOR EMERGENCY HELP IMMEDIATELY.
- Move the person to a warm dry area and remove any wet/tight clothing and replace with dry clothing or wrap in a blanket.
- Drink warm, sweet drinks (sugar water or sports-type drinks). Avoid caffeinated drinks.
- Have the person move their arms and legs to create muscle heat. If unable to do so, place hot packs in armpits, groin, neck and head. DO NOT rub the person or place them in warm water.

LOW TEMPERATURE + WIND SPEED + WETNESS = INJURIES & ILLNESS

- Little Danger (Caution) Freezing to Exposed Flesh within 1 hour:
- Danger Freezing to Exposed Flesh within 1 Minute:
- Extreme Danger Freezing to Exposed Flesh within 30 Seconds:

Source: OSHA; www.osha.gov

When the body is unable to warm itself, serious cold-related illnesses and injuries may occur, and permanent tissue damage and death may result.

Hypothermia can occur when land temperatures are above freezing or water temperatures are below 98.6°F/37°C. Cold-related illnesses can slowly overcome a person who has been chilled by low temperatures, brisk winds, or wet clothing.

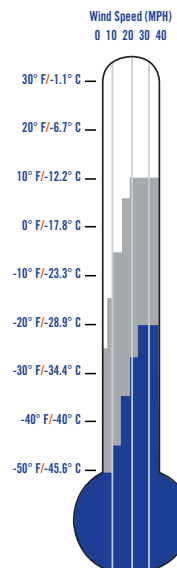

N-FERNO® WARMING PRODUCTS:

THERMAL BALACLAVA SERIES

DIFFERENTIATED BY DESIGN:

STRETCHABLE FLEECE

Stretchable fleece to ensure a great fit.

REFLECTIVE DETAIL

At center back of all balaclavas, a reflective accent has been added for visibility when in low light conditions.



LONG LENGTH

Long length for great coverage allowing for added warmth.

FLAME RESISTANT AND NON FLAME RESISTANT OPTIONS

Depending on your needs, stay toasty warm and flame free in FR balaclavas - you've got options!



6823

	6970	ORDER MULTIPLE 1
EXTREME BALACLAVA WITH HOT ROX™		
<ul style="list-style-type: none"> • 2-piece, fleece patented design • Built-in heat exchanger for warm air inhalation • Form-fitting design prevents eyewear from fogging • Adjustable mask with hook and loop attachments • Removable face mask 		
ITEM #	SIZE	COLOR
16971	—	Black
// PATENTED		

	6825	ORDER MULTIPLE 1
NOMEX BALACLAVA		
FR	NFPA 70E CAT 2 ATPV 9.7 cal/cm²	
<ul style="list-style-type: none"> • Nomex® fleece • Arc-rated; ATPV of 9.7 cal/cm² • Reflective accent for higher visibility • Stretchable and comfortable • Meets ASTM F1506; classified to NFPA 70E (CAT 2) 		
ITEM #	SIZE	COLOR
16825	—	Black

	6828	ORDER MULTIPLE 6
MODACRYLIC BLEND BALACLAVA		
FR	NFPA 70E CAT 2 ATPV 10.6 cal/cm²	
<ul style="list-style-type: none"> • Modacrylic blend fleece • Arc-rated; ATPV of 10.6 cal/cm² • Reflective accent for higher visibility • EN 1149 (Anti-Static) • Meets ASTM F1506; classified to NFPA 70E (CAT 2) 		
ITEM #	SIZE	COLOR
16828	—	Black

	6823	ORDER MULTIPLE 12
WIND-PROOF HINGED BALACLAVA		
 		
<ul style="list-style-type: none"> • Fleece with wind-protectant fabric • Unique hinged design • 3-panel construction for comfort • Reflective accent for higher visibility 		
ITEM #	SIZE	COLOR
16823	—	Black

	6824	ORDER MULTIPLE 12
WOOL BLEND BALACLAVA		
 		
<ul style="list-style-type: none"> • Polyester/wool blend, moisture wicking • Easily fits underneath a hard hat • Long length, lightweight and stretchable • Reflective accent for higher visibility 		
ITEM #	SIZE	COLOR
16824	—	Black

	6827	ORDER MULTIPLE 12
2-PC. FLEECE/NEOPRENE BALACLAVA		
 		
<ul style="list-style-type: none"> • 2-pc polyester fleece with neoprene face mask • 1mm neoprene, one side nylon and one side fleece • Long length • Reflective accent for higher visibility • Hook and loop suspensions to attach cap to a hard 		
ITEM #	SIZE	COLOR
16827	—	Black

	6826	ORDER MULTIPLE 12
2-PC. FLEECE BALACLAVA		
 		
<ul style="list-style-type: none"> • 2-pc polyester fleece attached by hook and loops • Unique hard hat hook and loop suspensions • Long length • Reflective accent for higher visibility 		
ITEM #	SIZE	COLOR
16826	—	Black

	6822	ORDER MULTIPLE 12
BALACLAVA WITH SPANDEX TOP		
 		
<ul style="list-style-type: none"> • Polyester fleece for warmth • Lightweight, stretchable spandex top • Long length • Reflective accent for higher visibility 		
ITEM #	SIZE	COLOR
16822	—	Black

	6821	ORDER MULTIPLE 12
BALACLAVA		
 		
<ul style="list-style-type: none"> • Polyester fleece for warmth • Long length • Reflective accent for higher visibility 		
ITEM #	SIZE	COLOR
16821	—	Black

N-FERNO® WARMING PRODUCTS:

THERMAL HAT & CAP SERIES

DIFFERENTIATED BY DESIGN:

GREAT FIT

Snug-fit to keep you safe and protected on the coldest of days.

REFLECTIVE DETAIL

Reflective accent for visibility when in low light conditions.

ADDED WARMTH

3M™ Thinsulate™ technology brings you added warmth for those cold winter days when added insulation is appreciated.

DURABLE SHELL

Durable, wind and water resistant nylon shell, great for sheltering you from the winter cold.



	6818	ORDER MULTIPLE 6
KNIT CAP		
<ul style="list-style-type: none"> • 100% acrylic shell • 3M™ Thinsulate™ flex insulation 40g • Soft fleece liner • One size 		
ITEM #	SIZE	COLOR
16818	—	Black

	6819_{BT}	ORDER MULTIPLE 6
KNIT CAP		
<ul style="list-style-type: none"> • 100% acrylic shell • CoolMax™ lining • 100% tenacious look 		
ITEM #	SIZE	COLOR
16819BT	—	Black

	6820	ORDER MULTIPLE 1
FR KNIT CAP		
<ul style="list-style-type: none"> • Shell: modacrylic cotton blend • Lining: modacrylic cotton blend fleece • Reflective accent for higher visibility • Arc Rated; ATPV rating of 49.5 cal/cm² • Meets ASTM F1506 and NFPA 70E (CAT 4) 		
ITEM #	SIZE	COLOR
16820	—	Black

	6802	ORDER MULTIPLE 1
CLASSIC TRAPPER™ HAT		
<ul style="list-style-type: none"> • Faux fur detail and quilted satin crown lining • Durable, wind and water-resistant nylon shell • 60 grams of Thinsulate™ Insulation from 3M • Button flaps with side holes for hearing • YKK buckle with strap 		
ITEM #	SIZE	COLOR
16843	S/M	Black
16845	L/XL	Black

	6810	ORDER MULTIPLE 12
STRETCH CAP - HALF CAP STYLE		
<ul style="list-style-type: none"> • 100% polyester knit • Half cap style • One size 		
ITEM #	SIZE	COLOR
16810	—	Black

	6815	ORDER MULTIPLE 12
STRETCH CAP - FULL FACE STYLE		
<ul style="list-style-type: none"> • 100% polyester knit • Full face style • One size 		
ITEM #	SIZE	COLOR
16815	—	Black

N-FERNO® WARMING PRODUCTS:

THERMAL ACCESSORY SERIES

DIFFERENTIATED BY DESIGN:



HOURS OF WARMTH

Self-contained packs add heat for hours when exposed to air.

ALL NATURAL

All natural ingredients that heat up, providing you with all natural warmth.

ACTIVATION

Simply open pack and expose to oxygen.

STOCK UP AND PUT 'EM TO USE!
MOST N-FERNO® WINTER LINERS
INCLUDE POCKETS NEAR THE
EARS FOR WARMING PACK USE.
TOASTED EARS FEEL BETTER!

<p>HAND WARMING PACKS</p>		<p>6990</p>	<p>ORDER MULTIPLE 40</p>						
<ul style="list-style-type: none"> • To activate, just open the pack • Natural ingredients heat up in contact with oxygen • Seal in ziploc bag and reuse the next day • Hand style warms up to 8 hours <table border="1" data-bbox="309 562 520 609"> <thead> <tr> <th>ITEM #</th> <th>SIZE</th> <th>COLOR</th> </tr> </thead> <tbody> <tr> <td>16990</td> <td>—</td> <td>—</td> </tr> </tbody> </table> 				ITEM #	SIZE	COLOR	16990	—	—
ITEM #	SIZE	COLOR							
16990	—	—							

<p>TOE WARMING PACKS</p>		<p>6992</p>	<p>ORDER MULTIPLE 40</p>						
<ul style="list-style-type: none"> • To activate, just open the pack • Natural ingredients heat up in contact with oxygen • Seal in ziploc bag and reuse the next day • Toe style warms up to 5 hours <table border="1" data-bbox="309 1129 520 1176"> <thead> <tr> <th>ITEM #</th> <th>SIZE</th> <th>COLOR</th> </tr> </thead> <tbody> <tr> <td>16992</td> <td>—</td> <td>—</td> </tr> </tbody> </table> 				ITEM #	SIZE	COLOR	16992	—	—
ITEM #	SIZE	COLOR							
16992	—	—							

<p>FOOT WARMING PACKS</p>		<p>6995</p>	<p>ORDER MULTIPLE 20</p>						
<ul style="list-style-type: none"> • To activate, just open the pack • Natural ingredients heat up in contact with oxygen • Seal in ziploc bag and reuse the next day • Foot style warms up to 7 hours <table border="1" data-bbox="309 1684 520 1730"> <thead> <tr> <th>ITEM #</th> <th>SIZE</th> <th>COLOR</th> </tr> </thead> <tbody> <tr> <td>16995</td> <td>—</td> <td>—</td> </tr> </tbody> </table> 				ITEM #	SIZE	COLOR	16995	—	—
ITEM #	SIZE	COLOR							
16995	—	—							



TREX™ FOOTWEAR ACCESSORIES

Brian Boitano WISHES he looked this smooth on the ice. While we can't guarantee you'll be pulling off triple Salchows with the greatest of ease, you will be making your way past the trickiest of terrain without breaking a hip or chipping a tooth. How, you ask? TREX™ Ice Traction. TREX™ sneers at the frictionless ice world of winter and takes the sting out of the slick, snowy ground. Fear no terrain with TREX™.

FOOTWEAR ACCESSORIES // ICE TRACTION SERIES



6300 One-Piece



6304 Performance One-Piece



6310 Adjustable One-Piece



6315 Strap-On Heel



6301 Replacement Studs

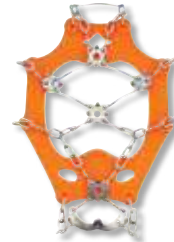

6320 Aggressive Spike

**TRACTION SPEAKS LOUDER
THAN WORDS.**



**TREX™
ICE TRACTION**

TREX
ICE
TRACTION

TREX™ ICE TRACTION:

ICE TRACTION SERIES

DIFFERENTIATED BY DESIGN:

STRETCHABLE RUBBER

Stretchable rubber construction for fit and easy on/off.

CONFIGURATION OPTIONS

One-piece designs for easy on/off or cinch tight for all-day wear.

STEEL STUDS

Heat-treated carbon steel studs deliver tenacious grip and stability.

SIZING OPTIONS

Available in multiple sizes to fit almost any boot or shoe.



6300

ORDER MULTIPLE
1

ONE-PIECE ICE TRACTION DEVICE

- 8 rugged, heat-treated carbon steel studs
- Stretchable rubber for fit and easy on/off
- Flexible to -40°F (-40°C)
- US: M (5-8), L (8-11), XL (11-14), 2XL (14-16)

ITEM #	SIZE	COLOR
16753	M	Black
16754	L	Black
16755	XL	Black
16756	2XL	Black

6304

ORDER MULTIPLE
1

PERFORMANCE ONE-PIECE ICE TRACTION DEVICE

- 12 rugged, heat-treated carbon steel studs
- Stretchable rubber construction
- Contoured, “step-in” design wraps around boots
- Flexible to -40°F (-40°C)
- US: S (5-7), M (7-9), L (9-11), XL (11-14)

ITEM #	SIZE	COLOR
16782	S	Black
16783	M	Black
16784	L	Black
16785	XL	Black

6310

ORDER MULTIPLE
1

ADJUSTABLE ONE-PIECE ICE TRACTION DEVICE

- 10 rugged, heat-treated carbon steel studs
- Adjustable cord cinches tight for a secure fit
- Stretchable rubber for fit and easy on/off
- Flexible to -40°F (-40°C)
- US: M (5-8), L (8-11), XL (11-14)

ITEM #	SIZE	COLOR
16773	M	Black
16774	L	Black
16775	XL	Black

6315

ORDER MULTIPLE
1

STRAP-ON HEEL ICE TRACTION DEVICE

- Corrosion-resistant steel heel plate
- Heel-only design leaves mid-foot free
- Channeled design will not retain ice or debris
- Rugged webbing, hook and loop strap
- Rear reflective accents enhance worker conspicuity

ITEM #	SIZE	COLOR
16777	M/L	Black
16778	XL+	Black

6301

ORDER MULTIPLE
1

REPLACEMENT STUDS

- 8 heat-treated carbon steel replacement studs
- Fits Trex™ 6300, 6304 and 6310 ice traction devices

ITEM #	SIZE	COLOR
16795	—	Orange

6320

ORDER MULTIPLE
1

AGGRESSIVE SPIKE ICE TRACTION DEVICE

- Stainless steel aggressive chain and spike system
- Innovative heel spike plate design
- Stretchable rubber ring ensures a secure fit
- Flexible to -40°F (-40°C)
- US: S (5-7), M (7-9), L (9-11), XL (11-14)

ITEM #	SIZE	COLOR
16742	S	HV Orange
16743	M	HV Orange
16744	L	HV Orange
16745	XL	HV Orange



CORE PERFORMANCE WORK WEAR®

Oh, it's on now! We've added an FR-compliant pullover, zip-up, and crew to the CORE Performance Work Wear® FR compendium of comfort. Now all your bases are covered in what can only be considered the best thing to happen to your body since the invention of skin. Every component is fit-perfect and ready to kick sweat out the door and keep cooling comfort and/or warmth in. One thing's for sure, quality layering is the not-so-subtle difference between a good day on the road and a bad case of road rash.

PERFORMANCE WORK WEAR // FR BASE LAYER SERIES



7415 Flame Resistant / LS Shirt

PERFORMANCE WORK WEAR // FR MID LAYER SERIES



7425 Flame Resistant / Crew Neck / LS



7430 Flame Resistant / Henley / LS

PERFORMANCE WORK WEAR // FR OUTER LAYER SERIES



7440 Flame Resistant / Pull Over



7445 Flame Resistant / Zip-Up

DON'T PLAY THE FLAME GAME.

CORE PERFORMANCE
WORK WEAR®

CORE PERFORMANCE WORK WEAR® :

FLAME RESISTANT SERIES

DIFFERENTIATED BY DESIGN:

COMPLIANT MATERIALS

All CORE FR™ Apparel meets requirements of ASTM F1506 and is classified according to NFPA 70E.

VISIBLE LABELING

Each garment has a visible FR tag including CAT level to ensure workers are wearing compliant gear.

MOISTURE WICKING

Moisture wicking material for multi-climate comfort.

COMFORTABLE DESIGNS

All garments are designed with comfort in mind - stretch fabric, flat seams, long tails, and relaxed fit: just to name a few...



7440

ORDER MULTIPLE
1

FR PULLOVER HOODED FLEECE SWEATSHIRT

FR

NFPA 70E CAT 2

ATPV 18.0 CAL/CM²

NFPA 2112

- 12.4oz, 100% FR cotton knit
- Moisture wicking and anti-stink for comfort
- Stretch fabric, lace closure hood, kangaroo pocket
- Hidden arm pocket for key or cellphone storage
- Meets ASTM F1506; CSA-Z462 compliant

ITEM #	SIZE	COLOR	ITEM #	SIZE	COLOR
40462	S	Gray	40472	S	Navy
40463	M	Gray	40473	M	Navy
40464	L	Gray	40474	L	Navy
40465	XL	Gray	40475	XL	Navy
40466	2XL	Gray	40476	2XL	Navy
40467	3XL	Gray	40477	3XL	Navy

7445

ORDER MULTIPLE
1

FR ZIP-FRONT HOODED FLEECE SWEATSHIRT

FR

NFPA 70E CAT 2

ATPV 18.0 CAL/CM²

NFPA 2112

- 12.4oz, 100% FR cotton knit
- Moisture wicking and anti-stink for comfort
- Stretch fabric and lace closure hood
- Multiple pockets and arm pocket for extra storage
- Meets ASTM F1506; CSA-Z462 compliant

ITEM #	SIZE	COLOR	ITEM #	SIZE	COLOR
40482	S	Gray	40492	S	Navy
40483	M	Gray	40493	M	Navy
40484	L	Gray	40494	L	Navy
40485	XL	Gray	40495	XL	Navy
40486	2XL	Gray	40496	2XL	Navy
40487	3XL	Gray	40497	3XL	Navy

// LAYER UP HOW TO ACHIEVE A HIGHER LEVEL OF ARC PROTECTION.

The only way you can achieve a higher level of arc protection is to layer up or purchase a heavier garment. Because of the air gaps (when layering clothing), the only way to determine the exact arc rating is to arc test the layers together.

Unfortunately, simple math won't work. You can't assume that if one garment has an 8 cal/cm² ATPV rating and the other garment has 10 cal/cm² ATPV rating, that when worn together they would rate an 18 cal/cm². To get an accurate rating, the layers must be arc tested together.

That's why we conducted ASTM F1959 arc testing on CORE FR™ garment combinations.

7440 OR 7445 + 7415 =

48 cal/cm²
CAT 4!!

HERE'S HOW THEY RATED: To equal this high of an arc rating with one garment, you'd need at minimum a 22 oz. fabric (that's HEAVY!). A layering system minimizes the bulk/weight while still achieving a high level of arc protection.



7415

ORDER MULTIPLE
1





ITEM #	SIZE	COLOR
40402	S	Gray
40403	M	Gray
40404	L	Gray

ITEM #	SIZE	COLOR
40405	XL	Gray
40406	2XL	Gray
40407	3XL	Gray

FR BASE LAYER LONG SLEEVE

FR

NFPA 70E CAT 2
 ATPV 6.0 CAL/CM²

- 5.8oz, 90% cotton 10% spandex (body)
- 5.3oz 85% FR cotton/8% Poly/7% Spandex (vents)
- Comfort design: stretch fabrics, long tail cut
- ATPV 7.4 cal/cm2 (body) & ATPV 6.0 cal/cm² (vents)
- Meets ASTM F1506; CSA-Z462 compliant



7425

ORDER MULTIPLE
1







ITEM #	SIZE	COLOR
40422	S	Heather Gray
40423	M	Heather Gray
40424	L	Heather Gray
40425	XL	Heather Gray
40426	2XL	Heather Gray
40427	3XL	Heather Gray

ITEM #	SIZE	COLOR
40432	S	Navy
40433	M	Navy
40434	L	Navy
40435	XL	Navy
40436	2XL	Navy
40437	3XL	Navy

FR CREW NECK LONG SLEEVE

FR

NFPA 70E CAT 2
 ATPV 8.2 CAL/CM²

NFPA 2112

- 6.7oz FR knit, Protex/Lyocell/Aramid
- Moisture wicking and anti-stink for comfort
- Comfort design: stretch fabrics, long tail cut
- Front chest pocket for storage
- Meets ASTM F1506; CSA-Z462 compliant



7430

ORDER MULTIPLE
1







ITEM #	SIZE	COLOR
40442	S	Heather Gray
40443	M	Heather Gray
40444	L	Heather Gray
40445	XL	Heather Gray
40446	2XL	Heather Gray
40447	3XL	Heather Gray

ITEM #	SIZE	COLOR
40452	S	Navy
40453	M	Navy
40454	L	Navy
40455	XL	Navy
40456	2XL	Navy
40457	3XL	Navy

FR HENLEY LONG SLEEVE

FR

NFPA 70E CAT 2
 ATPV 8.2 CAL/CM²

NFPA 2112

- 6.7-ounce FR knit, Protex/Lyocell/Aramid
- Moisture wicking and anti-stink for comfort
- Comfort design: stretch fabrics, long tail cut
- Front chest pocket for storage
- Meets ASTM F1506; CSA-Z462 compliant

FR EXPLAINED

Each year, hundreds of burn injuries and deaths are recorded from workers exposed to open flame, high heat, flash fire or arc flash without proper personal protective equipment (PPE). Getting into the numbers a bit... In 2013, the US Bureau of Labor Statistics reported approximately 148 worker fatalities due to fire and explosions and 139 fatalities due to exposure to electricity. That's 287 too many in our book. It's estimated that 5 to 10 arc flash explosions occur in electric equipment every day in the United States, with more than 3,600 disabling electrical contact injuries. It doesn't take a math degree to see that arc flash and flash fires are a matter of life and death. So, what's the solution? We start with education.*

National Fire Protection Association (NFPA 70E)

- Electrical safety standard aimed at end users that operate in the electrical utility industry
- Serves as a "how-to" guide to electrical arc safety
- Defines the level of arc rating needed by clothing to perform specific hazardous tasks where the potential for an arc flash exists
- CAT levels provide a minimum ATPV or E_{BT} rating which is part of the testing requirements for ASTM F1506, the design standard for manufacturer's to follow when making flame-resistant clothing
- All CORE FR™ garments appropriate for applications governed by NFPA 70E will be noted by the CAT level tech tag

NFPA 70E CAT 2

National Electrical Safety Code® (NESC®)

- Voluntary standard published by the Institute of Electrical and Electronics Engineers (IEEE)
- Used by electrical utilities to implement safety procedures for utility workers
- Requires utilities to perform a risk assessment and then requires workers to wear flame-resistant clothing with an effective CAT rating equal to the risk
- Most utility workers need to be in a minimum 8 cal/cm² arc-rated garment which can also be achieved through layering
- All CORE FR™ that has received an arc-rating will be noted with this tech tag

ATPV 8.2 CAL/CM²

National Fire Protection Association (NFPA 2112)

- Provides requirements for design, performance, certification requirements, and test methods for FR garments for use in areas at risk from flash fires. If a potential for flash fire exists, employees are required to wear flame-resistant clothing.
- Rigorous 3rd party testing required, along with garment certification, which requires an independent third-party organization to review & certify a finished garment guaranteeing that the whole product (from fabric to thread to zippers, buttons and trims) meet the standard's specifications & testing requirements
- As part of this garment certification, NFPA 2112 also requires an ongoing audit for FR garment manufacturers to verify their quality control process and ensure compliance
- All CORE FR™ that has been 3rd party certified to this standard will noted with this tech tag

NFPA 2112

FR SOLUTIONS: STACK THE ODDS IN YOUR FAVOR

When arc flash and flash fires are a risk, it's no time to cut corners especially when it comes to your last line of defense – the clothes you wear. That's why choosing trusted fabrics is not only mission critical, it also can be life-saving. These industry-leading, US fabric manufacturers use top notch materials to ensure compliance and superior comfort, quality, durability – and, most importantly, protection against arc flash and flash fires.

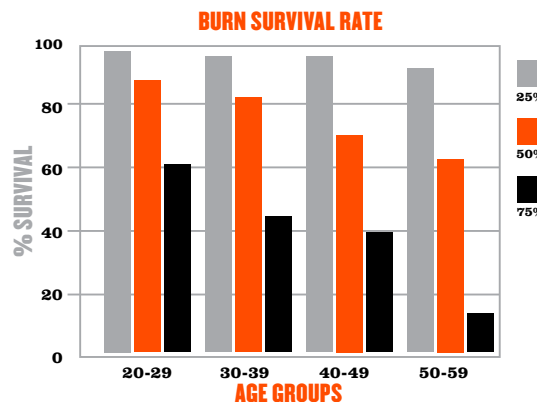

* CDC, NFPA, NSA & BLS

FLAME RESISTANT COLLECTION:

BECAUSE FR DOESN'T HAVE TO SUCK.

We've tackled many a worker issue over the past three decades – none as serious or mission critical as FR. And so, we couldn't be more proud to add CORE Performance Work Wear® FR to our top flight, battle-tested lineup of Tenacious Work Gear®. Made of the best fabric technologies on the planet that provide certified arc and flash fire protection – all designed with worker comfort, performance, and even swagger in mind. This fashion-forward, flame-squelching gear would make even Vulcanus Rex himself stop and think twice.

In this handy dandy overview, you'll find a selection of products designed to serve and protect. The best part {we humbly think} are the bountiful protective solutions contained herein that will take care of workers on the job and, most importantly, ensure they get home safely at the end of each day and back on the job tomorrow.

Chill-Its COOLING PRODUCTS

N-FERNO WARMING PRODUCTS

GLÖWEAR HI-VIS APPAREL

CORE PERFORMANCE WORK WEAR®



COOLING PRODUCTS //



6700FR Tie Bandana w/ Polymers

COOLING PRODUCTS //



6215 Premium Cooling Vest

WARMING PRODUCTS //



6872 2-Layer FR Mouth Pc.

HI-VIS PRODUCTS //



8260FRHL Flame Resistant

PERFORMANCE WORK WEAR //



7415 Flame Resistant / LS Shirt



6705FR H&L Bandana w/ Polymers



6710FR Triangle Hat w/ Polymers



6717FR HH Neck Shade w/ Polymers



6486 Flame Resistant Multi-band



6215HV Hi-Vis Premium Cooling Vest

WARMING PRODUCTS //



6885 2-Way FR Liner



6880 2-Layer FR Liner



6882 2-Layer FR Liner



6890 3-Layer FR Liner



6892 3-Layer FR Liner



6825 Nomex FR Balaclava



6828 Modacrylic FR Balaclava



6820 FR Knit Cap



8356FRHL Flame Resistant



8396FR Hooded Sweatshirt



7425 Flame Resistant / Crew Neck / LS



7430 Flame Resistant / Henley / LS



7440 Flame Resistant / Pull Over



7445 Flame Resistant / Zip-Up

**FIND YOUR FIT, GET YOUR GEAR AND
FIND THE PAGE NUMBER RIGHT HERE.**



THE NITTY GRITTY

WHERE'S THAT...

There's plenty of people in this world that'll never stop and ask for directions – or look at an index for that matter. Well, for those of you who will, here you go. Enjoy.

Model	Page	Model	Page	Model	Page	Model	Page	Model	Page	Model	Page	Model	Page	Model	Page
100	48	818WP	31	3218	86	5183	119	5815	136	6700FR	153	7415	192	8910	63
100HV	48	819OD	30	3222	86	5184	119	5817	136	6700MF	149	7425	192	8911	63
200	41	819WP	31	3225	86	5193	118	5840	137	6705	152	7430	192	8915	71
210	41	820	27	3251	87	5210	123	5843	137	6705CT	150	7440	191	8918	71
230	41	821	25	3275	87	5215	123	5850	139	6705FR	153	7445	191	8925	71
260	41	840	27	3280	87	5216	123	5870	138	6705MF	149	8001	73	8930	73
300	40	860	25	3311	105	5220	123	5872	138	6710	152	8003	73	8935	72
315	40	876WP	31	3386	108	5243	123	5875	139	6710CT	150	8004	73	8935CT	151
325	40	900	20	3400	111	5244	123	5876	139	6710FR	153	8006	73	8935MF	149
335	41	901	21	3405	111	5500	135	5888	138	6710MF	149	8008	73	8940	72
340	41	910	21	3410	110	5504	135	5920	139	6715	152	8010	65	8950	91
342	37	920	22	3415	110	5506S	135	5925	139	6715CT	150	8020	65	8955	91
344	37	921	23	3540	111	5516	133	6000	165	6716	152	8040	65	8960	91
345	37	922	23	3601	111	5518	133	6010	165	6717	152	8080	65	9000	21
347	38	924	23	3700	102	5522	134	6094	165	6717CT	151	8080	67	9002	21
349	38	925F(x)	22	3703	102	5528	133	6100	165	6717FR	153	8091	67	9012	21
350	38	925F(x)CP	23	3713	102	5532	134	6190	165	6802	181	8140	65	9015	20
355	38	925F(x)CPWP	23	3723	103	5538	133	6191	165	6810	181	8205	59	BALDR	83
357	38	925F(x)WIP	23	3724	103	5548	134	6215	159	6815	181	8210	59	DAGR	83
367	38	1051	49	3726	103	5550	132	6220	159	6818	181	8215	59	ERDA	84
375	43	1100SF	48	3750	103	5555	132	6230	159	6819BT	181	8220	59	KVASIR	84
380	43	1400UN	49	3755	103	5560	132	6240	159	6820	181	8225	59	LOKI	85
385	43	1500	49	3770	103	5567	134	6300	187	6821	179	8229	59	NJORD	85
390	43	1505	49	3780	103	5580	161	6301	187	6822	179	8230	60	ODIN	82
400	52	1600	49	3790	103	5581	161	6304	187	6823	179	8235	60	THOR	83
420	52	1650	49	4000	51	5638	127	6310	187	6824	179	8240	61	VALKYRIE	84
500	53	2000SF	48	4010	51	5650	124	6315	187	6825	178	8244	61		
600	53	3000	107	4020	51	5653	126	6320	187	6826	179	8245	61		
615	53	3001	107	5005	121	5700	134	6435	173	6827	179	8248	60		
620	53	3025	107	5008	121	5706	134	6463	173	6828	178	8249	60		
650	53	3026	107	5020	117	5725	133	6465	173	6840	176	8250	60		
655	53	3100	104	5030	117	5728	133	6470	173	6842	176	8254	61		
670	51	3101	105	5060	121	5730	125	6480	173	6850	176	8255	61		
675	51	3102	104	5063	121	5732	125	6485	157	6852	176	8260FR	61		
710	26	3103	102	5080	118	5733	126	6486	157	6860	176	8289	66		
710CL5	26	3104	106	5082	118	5734	126	6490	171	6862	176	8289	67		
710LTR	27	3108	105	5092	121	5735	125	6500	157	6863	175	8291	66		
710TX	27	3109	105	5093	121	5737	127	6550	157	6867	175	8293	68		
720	27	3110	104	5115	117	5738	127	6602	151	6870	176	8295	67		
720LTR	27	3111	105	5116	117	5739	127	6602MF	149	6872	176	8310	62		
730	29	3114	106	5120	116	5740	125	6603	151	6873	175	8320	63		
7300D	29	3115	106	5125	116	5742	125	6605	156	6877	175	8330	63		
800	21	3116	106	5130	119	5743	126	6607	157	6880	175	8356FR	63		
810	25	3119	105	5143	117	5744	126	6609	157	6882	175	8365	70		
811	24	3130	106	5144	117	5745	125	6615	156	6885	175	8379	71		
812	24	3150	108	5151	161	5760	124	6630	156	6890	175	8380	71		
812CL5	25	3155	108	5155	161	5763	126	6650	156	6892	175	8385	70		
812TX	25	3157	108	5156	160	5780	138	6660	157	6950	175	8391	67		
815	25	3158	108	5157	160	5782	138	6665	154	6952	175	8392	68		
816	31	3175	106	5158	161	5802	137	6670CT	151	6970	178	8393	68		
817	31	3200	87	5180	119	5804	137	6685	154	6990	183	8396FR	68		
817WP	31	3215	87	5181	119	5808	137	6700	152	6992	183	8397	68		
818OD	30	3216	86	5182	119	5810	137	6700CT	151	6995	183	8399	68		



PICK ON SOMETHING YOUR OWN SIZE

Put those middle school memories to bed because fitting in couldn't be easier with our Tenacious Work Gear® coming in a wide range of sizes and styles. No more sitting by yourself in the cafeteria because you wore a New Kids On The Block shirt two years too late or your hyper color tee went through the dryer and stopped working. Visit www.ergodyne.com for sizing.



**ProFlex®
Gloves**

Measure around the palm. **DO NOT** include the thumb area. Use the size chart across the bottom of this page to double check your size choice.



**ProFlex®
Wrist Supports**

Measure around the smallest part of the wrist.



**ProFlex®
Wrist Wraps**

Measure around the smallest part of the wrist.



**ProFlex®
Elbow Supports**

In a relaxed position, measure around the widest area of the forearm just below the elbow. For best fit, an elbow support should sit about 2-3 finger widths below the elbow crease.



**Ergodyne®
Knee Sleeves**

Measure around the center of the knee with the knee extended.

SIZE:	FITS HANDS:	FITS WRISTS:	FITS WRISTS:	FITS ELBOWS:	FITS KNEES:
X-Small	Sz. 6: up to 7" (18 cm)	-----	-----	up to 9" (23 cm)	12-13" (31-33 cm)
Small	Sz. 7: 7-8" (18-20 cm)	up to 6" (15 cm)	-----	9-10" (23-25 cm)	13-14" (33-36 cm)
Medium	Sz. 8: 8-9" (20-23 cm)	6-7" (15-18 cm)	-----	10-11" (25-28 cm)	14-15" (36-38 cm)
Large	Sz. 9: 9-10" (23-25 cm)	7-8" (18-20 cm)	-----	11-12" (28-30 cm)	15-16" (38-41 cm)
X-Large	Sz.10: 10-11" (25-28 cm)	8" and over (20 cm)	-----	12-13" (30-33 cm)	16-18" (41-46 cm)
2XLarge	Sz.11: 11-12" (28-30 cm)	-----	-----	13-16" (33-36 cm)	18-20" (46-51 cm)
3XLarge	Sz.12: 12-13" (30-32 cm)	-----	-----	-----	-----
4XLarge	-----	-----	-----	-----	-----
S/M	-----	-----	5-7" (15-19 cm)	-----	-----
L/XL	-----	-----	7-9" (19-23 cm)	-----	-----

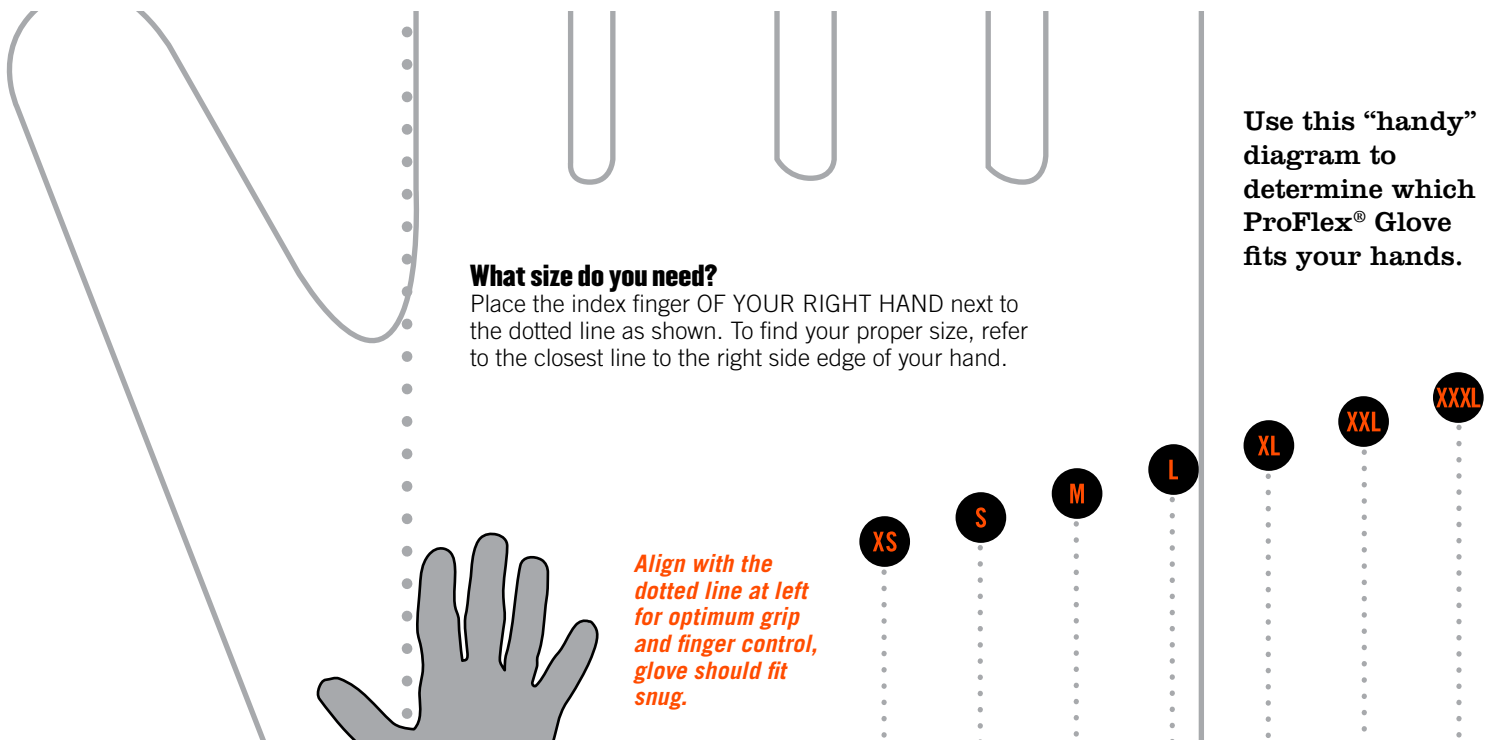

**TREX™
Ice Traction**

Use shoe or boot size to determine the appropriate size. TREX™ Ice Traction should fit snugly.



SIZE:	6300			6310			6304 // 6320			6315		
	USM	UK	EU	USM	UK	EU	USM	UK	EU	USM	UK	EU
Small	-----			-----			5-7	4.5-6.5	37-40	5-7	4.5-6.5	37-40
Medium	5-8	4.5-7.5	37-41	5-8	4.5-7.5	37-41	7-9	6.5-8.5	40-42	7-9	6.5-8.5	40-42
Large	8-11	7.5-10.5	41-44	8-11	7.5-10.5	41-44	9-11	8.5-10.5	42-44	9-11	8.5-10.5	42-44
X-Large	11-14	10.5-13.5	44-47	11-14	10.5-13.5	44-47	11-14	10.5-13.5	44-47	11-14	10.5-13.5	44-47
2XLarge	14-16			-----			-----			-----		
3XLarge	-----			-----			-----			-----		

**ProFlex®
Back Supports**

Measure around the waist. A support should fit snugly, but not so tightly that it cannot be cinched firmly when ready to lift.

**N-Ferno®
Base Layer Bottoms**

Use standard waist size measurement.

**N-Ferno®
Base Layer Shirts**

If you are not comfortable with snug fitting compression garments you may want to upsize on the base layer ripped fit models.

**N-Ferno®
Outerwear Jacket**

Bring tape measure around the widest part of your chest, under your arms, completely around your torso.

**N-Ferno®
Outerwear Bibs**

Use standard waist size measurement.

SIZE:	FITS WAISTS:	FITS WAISTS:	FITS CHEST SIZE:	FITS CHEST SIZE:	FITS WAISTS:
X-Small	Up to 25" (64 cm)	-----	-----	-----	-----
Small	25-30" (64-76cm)	-----	-----	34-36" (86-91 cm)	-----
Medium	30-34" (76-86cm)	31-34" (79-86cm)	38-41" (97-104cm)	36-38" (91-97 cm)	30-34" (76-86 cm)
Large	34-38" (86-97cm)	34-37" (86-94cm)	41-44" (104-112cm)	38-42" (97-107 cm)	34-38" (86-97 cm)
X-Large	38-42" (97-107cm)	37-40" (94-102cm)	44-47" (112-119cm)	42-46" (107-117 cm)	38-42" (97-107 cm)
2XLarge	42-46" (107-117cm)	40-44" (102-112cm)	47-50" (119-127cm)	46-50" (117-127 cm)	42-46" (107-117 cm)
3XLarge	46-52" (117-132cm)	44-48" (112-122cm)	50-53" (127-135cm)	50-54" (127-137 cm)	46-48" (117-123 cm)
4XLarge	52-58" (132-147cm)	-----	-----	-----	-----



**GloWear®
Hi-Vis Shirts**

T-Shirt, Polo Shirt, and Sweatshirt are individually sized S, M, L, XL, 2XL, 3XL, 4XL, 5XL and follow standard sizing.



**GloWear®
Hi-Vis Vests**

Vests & Vests w/Sleeves are sold in combined sizes: S/M, L/XL, 2XL/3XL, and 4XL/5XL. *Note: 8240HL is available in M/L and XL/2XL only.



**GloWear® Pants
8910/8911**

Use standard waist size measurement.



**GloWear® Pants
8915/8925**

Use standard waist size measurement.



**GloWear®
Jackets**

Bring tape measure around the widest part of your chest, under your arms, completely around your torso.

SIZE:	FITS CHEST SIZE:	FITS CHEST SIZE:	FITS WAIST SIZE:	FITS WAIST SIZE:	FITS CHEST SIZE:
Small	34-36" (86-91 cm)	-----	-----	Up to 30" (76 cm)	34-36" (86-91 cm)
Medium	36-38" (91-97 cm)	-----	-----	30-34" (76-86 cm)	36-38" (91-97 cm)
Large	38-42" (97-107 cm)	-----	-----	34-38" (86-97 cm)	38-42" (97-107 cm)
X-Large	42-46" (107-117 cm)	-----	-----	38-42" (97-107 cm)	42-46" (107-117 cm)
2XLarge	46-50" (117-127 cm)	-----	-----	42-46" (107-117 cm)	46-50" (117-127 cm)
3XLarge	50-54" (127-137 cm)	-----	-----	46-48" (117-123 cm)	50-54" (127-137 cm)
4XLarge	54-58" (137-147 cm)	-----	-----	48-50" (123-127 cm)	54-58" (137-147 cm)
5XLarge	58-62" (147-157 cm)	-----	-----	50-54" (127-137 cm)	58-62" (147-157 cm)
S/M	-----	36-44" (91-112 cm)	Up to 40" (102 cm)	-----	-----
M/L (8240HL only)	-----	40-48" (102-123 cm)*	-----	-----	-----
L/XL	-----	44-52" (112-132 cm)	40-46" (102-117 cm)	-----	-----
XL/2XL (8240HL only)	-----	48-56" (123-142 cm)*	-----	-----	-----
2XL/3XL	-----	52-58" (132-147 cm)	46-52" (117-132 cm)	-----	-----
4XL/5XL	-----	58-64" (147-163 cm)	52-58" (132-147 cm)	-----	-----

For full sizing of all Ergodyne items see www.ergodyne.com



**Chill-Its®
Cooling Vest 6665**

Bring tape measure around the widest part of your chest, under your arms, completely around your torso.



**Chill-Its®
Cooling Vest 6685**

Bring tape measure around the widest part of your chest, under your arms, completely around your torso.



**Chill-Its®
Phase Change Vests**

Bring tape measure around the widest part of your chest, under your arms, completely around your torso.



**Arsenal®
Synthetic Rigs**

Choose your synthetic belt size based on your pant waist size.

SIZE:	FITS CHEST SIZE:	FITS CHEST SIZE:	FITS CHEST SIZE:	FITS WAIST SIZE:
X-Small	-----	-----	-----	-----
Small	-----	-----	32-40" (81-102 cm)	-----
Medium	36-38" (91-97 cm)	38-41" (97-104 cm)	32-40" (81-102 cm)	-----
Large	38-42" (97-107 cm)	41-44" (104-112 cm)	40-52" (102-132 cm)	29-38" (74-97cm)
X-Large	42-46" (107-117 cm)	44-47" (112-119 cm)	40-52" (102-132 cm)	36-44" (91-112cm)
2XLarge	46-50" (117-127 cm)	47-50" (119-127 cm)	-----	42-49" (107-125cm)
3XLarge	50-54" (127-137 cm)	50-53" (127-135 cm)	-----	-----
4XLarge	-----	53-56" (135-142 cm)	-----	-----

SIZE UP THE SITUATION

Improperly sized gear is a prime cause of heartache and sadness. Remember when you showed up at school wearing high-water pants? Of course that's nothing compared to the crack-tacular combination of too-short shirt and too-loose pants. Don't let these calamities occur. Your gear will be more effective and comfortable if you choose appropriate sizes.



CHEST: Measurement should be taken around the fullest part of the chest with arms down, just under the arms and across the shoulder blades.

WAIST: Measure around waist (not pulling tightly) at the height you prefer to wear the waistband.

INSEAM: Take a pair of pants that fit you well and measure from the crotch to the bottom of the leg.

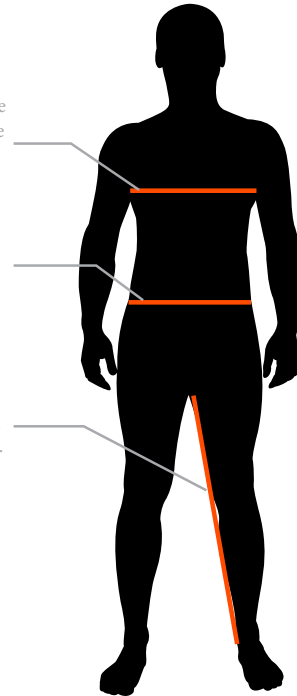

BASE LAYER SHIRT MODEL 7415

	SMALL	MEDIUM	LARGE	X-LARGE	2X-LARGE	3X-LARGE
CHEST	36-38" 92-97 cm	39-42" 99-108 cm	43-46" 109-117 cm	47-50" 118-127 cm	51-54" 128-137 cm	55-58" 138-147 cm

*Please note: this model will shrink in the wash, so if measurements are in between sizes, buy the larger size.

MID LAYER SHIRTS MODELS 7425 // 7430

	SMALL	MEDIUM	LARGE	X-LARGE	2X-LARGE	3X-LARGE
CHEST	34-36" 87-92 cm	37-40" 93-102 cm	41-44" 103-112 cm	45-48" 113-122 cm	49-52" 124-132 cm	53-56" 133-142 cm

SWEATSHIRTS MODELS 7440 // 7445

	SMALL	MEDIUM	LARGE	X-LARGE	2X-LARGE	3X-LARGE
CHEST	36-38" 92-97 cm	39-41" 99-103 cm	42-44" 108-112 cm	45-48" 113-122 cm	49-52" 124-132 cm	53-60" 133-152 cm

WE STAND BEHIND EVERYTHING WE MAKE AND GUARANTEE OUR PRODUCTS TO BE FREE OF DEFECTS IN MATERIALS AND WORKMANSHIP TO THE ORIGINAL PURCHASER FOR THE LIFETIME OF THE PRODUCT.

(DAMAGE, ABUSE, AND/OR NORMAL WEAR ARE NOT COVERED. DON'T LAWYERS JUST BRING YOU DOWN?)





**WORK SAFELY //
LIVE TENACIOUSLY**

Tool Box
Machine Shop
Wrenching on Cars

Dirt Bikes
Denim Blue
Closing Down Bars

Duck Blinds
Daily Grinds
Steel Toed Boots

Red Blooded
Clear Eyed
Putting Down Roots

Campgrounds
Sturgis
Hook, Line, and Sinker

Cookouts
Miller Time
Sun Grows Pinker

Trench and Dredge
Lay out Block
Snap the Line
Punch the Clock

Keep it Safe
Best in Show
Bell Rings
Time to Go

Homeward Bound
Wild and Free
A Life Well Lived
Tenaciously



Do not burn yourselves out. Be as I am — a reluctant enthusiast... a part-time crusader, a half-hearted fanatic. Save the other half of yourselves and your lives for pleasure and adventure. It is not enough to fight for the land; it is even more important to enjoy it. While you can. While it's still here. So get out there and hunt and fish and mess around with your friends, ramble out yonder and explore the forests, climb the mountains, bag the peaks, run the rivers, breathe deep of that yet sweet and lucid air, sit quietly for a while and contemplate the precious stillness, the lovely, mysterious, and awesome space. Enjoy yourselves, keep your brain in your head and your head firmly attached to the body, the body active and alive, and I promise you this much; I promise you this one sweet victory over our enemies, over those desk-bound men and women with their hearts in a safe deposit box, and their eyes hypnotized by desk calculators. I promise you this; You will outlive the bastards.

– Edward Abbey

MEMBER ASSOCIATIONS:



AFFLONK



INCOM
Distributor Supply



Indica
MARKETING GROUP



NETPLUS
ALLIANCE



SMG



VPP



INTERGALACTIC HEADQUARTERS:
44° 58' 18.31" N 93° 09' 12.88" W ALT. 934 FT.
1021 BANDANA BOULEVARD EAST
SUITE 220 SAINT PAUL, MN, USA 55108
PHONE 651 642 9889 // 800 225 8238
WWW.ERGODYNE.COM

©2015 Tenacious Holdings Inc. All Rights Reserved. All Wrongs Reversed. Ergodyne, Ergoman and Ergoman design, Tenacious Work Gear Logo, Ergodyne Tenacious Work Gear, Arsenal, Chill-Its, DROP COPS, GloWear, Nu202, Squids, Sticky Fingers, ProFlex, CORE Performance Work Wear, N-Ferno, SHAX and Skullerz are registered trademarks of Ergodyne and protected in the U.S. and abroad. Be Tenacious, BET (Beverage Extrication Tool), Open-Center Stay, Perfor-air, Power Panel Positioner, Storm Drains, Products for Occupational Athletes, Trex, Hot Rox, Tenacious-U, Tool Tails, Tool Traps, ZeroRebound, Lil' Buddies, Tenacious Testers, Tenacious Nation, Make the Workplace a Betterplace, Drops Free Zone and Tenacious Talks are trademarks of Ergodyne. Trademarks of companies mentioned herein appear for identification purposes only and are the property of their respective companies. All other product names mentioned herein may be trademarks and/or registered trademarks of their respective owners. Ergodyne is a division of Tenacious Holdings Inc.